

Foreword

This service manual provides maintenance guidelines for KYMCO AHG1 fuel injection engine.

Chapter 1 contains all the operational precautions that you should read carefully before you start.

Chapter 3 gives inspection and fine-tuning tips and maintenance of individual functions beginning with regular inspection.

The remaining chapters outline assembly/ disassembly and inspection steps for the engine, and electrical system.

Each chapter begins with an overall explanation of the exploded diagram, system diagram, maintenance troubleshooting, and diagnosis description.

ALL INFORMATION, GRAPHICS AND SPECIFICATIONS CONTAINED IN THIS DOCUMENT ARE BASED ON THE LATEST PRODUCT INFORMATION AVAILABLE AT THE TIME OF MANUFACTURE. KWANG YANG MOTOR CO., LTD. RESERVES THE RIGHT TO MAKE CHANGES AT ANY TIME WITHOUT NOTICE AND WITHOUT INCURRING ANY OBLIGATION WHATEVER.

ALL RIGHTS RESERVED. ANY REPRODUCTION OR UNAUTHORIZED USE WITHOUT THE WRITTEN PERMISSION OF KWANG YANG MOTOR CO., LTD. IS STRICTLY PROHIBITED.

© KWANG YANG MOTOR CO., LTD.
By the Technology Training Section
First Edition – Jun. 2021

	Quick Reference	1
	External Components	2
	Periodic Maintenance	3
Engine	Lubrication System	4
	Engine Removal/ Installation	5
	Cylinder Head/ Valve	6
	Cylinder/ Piston	7
	Drive & Driven Pulley	8
	Final Reduction	9
	Alternator / Start Clutch	10
	Crankcase/ Crankshaft	11
	Cooling System	12
	Fi System	13
Frame	Front Assembly	14
	Rear Assembly	15
Electrical	Battery & Charging System	16
	Ignition System	17
	Starting System	18
	Switches/ Lights	19
EEC	EEC System	20
ABS	ABS/TCS	21

Quick Reference

1. Engine /Frame Serial Number.....	2
2. Specifications.....	3
3. Operation precautions	4
4. Torque.....	5
4.1. General Torque Value	5
4.2. Engine	6
4.3. Frame	7
5. Special Tool.....	8
6. LUBRICATION POINTS-FRAME.....	9
7. Components Location	10
8. General Troubleshooting.....	13
8.1. Engine lacks power	13
8.2. Engine will not start or is hard to start.....	15
8.3. Poor handling.....	16
8.4. Poor performance at high speed.....	17
8.5. Poor performance at low and idle speed.....	18

1. Engine /Frame Serial Number

Frame Serial Number



Engine Serial Number

1. Quick Reference



2. Specifications

Model Code		AHG1			
Overall Length (mm)		2165			
Overall Width (mm)		780			
Overall High (mm)		1290			
Wheel Base (mm)		1545			
Engine Type		Four Stroke OHC			
Displacement (cc)		124			
Fuel Recommended		None lead 92#			
Curb Weight (kg)	Front Wheel	80			
	Rear Wheel	99			
	Total	178			
Max. weight capacity (kg)	Front Wheel	125			
	Rear Wheel	219			
	Total	344			
Tires	Front Wheel	120/80-14 58S			
	Rear Wheel	150/70-13 64S			
Ground clearance (mm)		135			
Performance	Braking distance (m)		7.9m/ 40km/h		
	Min. turning radius (mm)		R/L 2545		
Engine	Starting system		Starting motor		
	Type		Gasoline, 4-stroke		
	Cylinder arrangement		Single Cylinder		
	Combustion chamber type		Semi-sphere		
	Valve arrangement		OHC		
	Bore x stroke (mm)		ø54*54.3		
	Compression ratio		11.2±0.2		
	Compression pressure (kgf/cm ²)		15		
	Max. Horsepower (ps/rpm)		21.0/7500		
	Max. Torque (kg-m/rpm)		1.12/7000		
	Valve clearance (cold) (mm)	Intake	0.1		
		Exhaust	0.1		
	Idle speed (rpm)		1700±100		
	Lubricate System	Lubrication type		Forced pressure & Wet sump	
		Oil Pump Type		Inner/outer rotor type	
		Oil Filter Type		Full-flow filtration	
		Engine Oil	Disassembly	1.2L	
			Exchange	1.0L	
		Gear Oil	Disassembly	0.13L	
Exchange	0.12L				

Cooling System	Cooling Type		Liquid Cooling		
	Coolant capacity	Coolant radiator	0.87L		
		Reserve tank	0.49L		
FI System	Air cleaner type & No		Paper element, wet		
	Fuel capacity		12.5L		
	Throttle Body	Type		M4C	
		Venturi dia (mm)		ø27	
Throttle Valve		Butterfly type			
Electrical Equipment	Ignition System	Type		Inductive Ignition Coil	
		Ignition Timing		ECU Controls	
		Spark plug	Spec	NGK-CPR7EA	
	Gap (mm)		0.7 ~ 0.8		
	Battery Capacity		12V 8Ah		
Power Drive System	Clutch	Type		Dry Multi-clutch	
		Transmission Gear	Type		CVT
	Operation		Automatic centrifugal type		
	Reduction Gear		Type		2-staged Reduction
		Reduction Ratio	1 st	0.83~2.2	
2 nd	10.41				
Moving Device	Wheel Type		Tubeless		
	Rim Material		Aluminum		
	Tire Pressure (kgf/cm ²) (2 People)	Front Wheel	2.0		
		Rear Wheel	2.25		
	Turning Angle	Left	40°		
		Right	40°		
Brake System Type		Front	Single Disk (260)		
		Rear	Single Disk (240)		
Damping	Suspension Type		Front	TELESCOPE	
			Rear	Dual damper unit swing arm	
Chassis Type		UNDER BONE			

3. Operation precautions

If any gaskets, O-rings, circlips and cotter pins are removed, they need to be replaced with new ones.

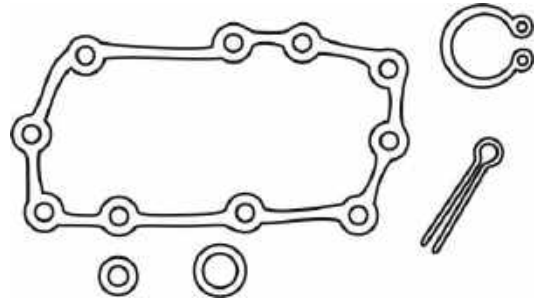

Tighten the screws and nuts from the one with bigger outer diameter diagonally to the specified torque.

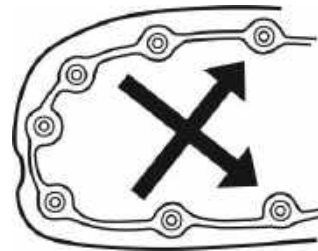

We recommend that you use genuine lubricants and parts.

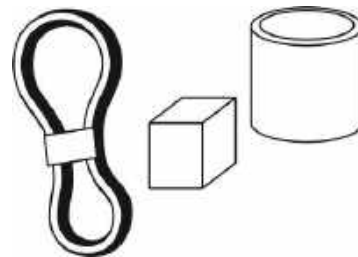

Please use dedicated or common tools when working on any assembly and disassembly of the parts during service operation.



After dismantling, the parts to be inspected should be cleaned. During assembly, apply oil to the frictional surface between parts for lubrication.

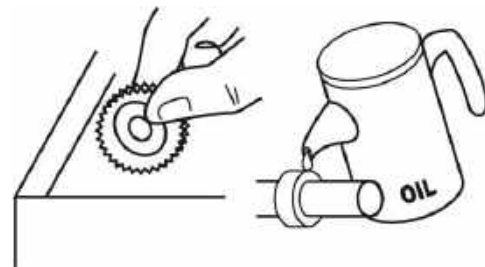

Apply recommended lubricant on the specified positions.

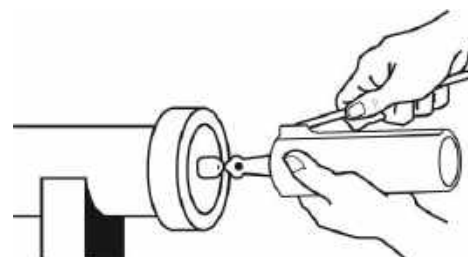

4. Torque

4.1. General Torque Value

Item	Torque (kgf· m)	Item	Torque (kgf· m)
5mm Bolt/ Nut	0.45~0.6	4mm Tapping screw (Cut)	0.05~0.15
6mm Bolt/ Nut	0.8~1.2	4mm Tapping screw (Point)	0.2~0.4
8mm Bolt/ Nut	1.8~2.5	5mm screw (Cut)	0.1~0.3
10mm Bolt/ Nut	3.0~4.0	5mm Tapping screw (Point)	0.35~0.5
12mm Bolt/ Nut	5.0~6.0	6mm screw /SH bolt	0.7~1.1
14mm Bolt/ Nut	6.0~8.0	6mm Flange bolt/ Nut	1.0~1.4
		8mm Flange bolt/ Nut	2.4~3.0
		10mm Flange bolt/ Nut	3.5~4.5

1. Quick Reference

4.2. Engine

No.	ITEM	TORQUE		Remarks	DWG No.
		N-m	Kgf-m		
1	Bolt B Stud 8*210	6.9~10.8	0.7~1.1	Stud side	90032-KHD6-9000
2	Bolt B Stud 8*218	6.9~10.8	0.7~1.1	Stud side	90031-KHD6-9000
3	Tappet ADJ hole cap	9.8~19.6	1.0~2.0		12361-GFY6-9010
4	L Cover	7.8~8.8	0.8~0.9		9000A-KTDT-9000
5	Tube/ wire clamper	7.8~8.8	0.8~0.9		9000A-KTDT-9000
6	Cylinder head	6.9~10.8	0.7~1.1	Inlet pipe area	92900-06050-0B
		6.9~10.8	0.7~1.1	EX pipe area	90033-GFY6-9000
		6.9~10.8	0.7~1.1	A/I pipe area	90033-GFY6-9410
		17.7~21.6	1.8~2.2		94050-08080
7	Cylinder head cover	7.8~8.8	0.8~0.9		9000B-KHD6-9000
8	Cam shaft set plate	9.8~13.7	1.0~1.4		9000z-GFY6-9010
9	Breather separator plate	2.5~3.9	0.25~0.4		93903-34120
10	Tappet ADJ nut	6.9~10.8	0.7~1.1	Apply oil	90206-0A01-0010
11	Cam chain tensioner pivot	7.8~11.8	0.8~1.2		14531-GLR0-0010
12	Tensioner lifter	9.8~13.7	1.0~1.4		90001-GBHB-6610
13	Tensioner lifter	3.4~4.9	0.35~0.5		90005-KAW1-9010
14	Oil pump	6.9~10.8	0.7~1.1		96001-06028-08
15	Reed valve	9.8~13.7	1.0~1.4		95701-06040-00
					95701-06025-00
16	A/I pipe	9.8~13.7	1.0~1.4		90304-4H38-0010
17	Mission cover	9.8~13.7	1.0~1.4		96001-06025-08
					96001-06032-08
18	L case gear oil drain bolt	7.8~11.8	0.8~1.2		95701-08012-08
19	L case engine oil drain bolt	19.6~29.4	2.0~3.0		9052A-LEB1-9000
20	Drive face	53.9~63.7	5.5~6.5	Apply oil	94050-12000
21	Clutch outer	49~58.9	5.0~6.0		94050-10080
22	Drive plate COMP	49~58.9	5.0~6.0		90202-IG87-0010
23	ACG flywheel	49~58.9	5.0~6.0		94080-12000
24	Spark plug	9.8~13.7	1.0~1.4		98056-57713-00
					98056-57723-02
25	One-way clutch	17.6~24.5	1.8~2.5		96600-08015-10
26	Water pump impeller	9.8~13.7	1.0~1.4	L.H. screw	19215-KHE7-9000
27	Thermo unit	7.8~11.8	0.8~1.2		37750-PAC1-0050
28	ACG stator	7.8~9.8	0.8~1.0		92101-05032-0H
29	ACG pulse	3.9~6.8	0.4~0.7		93500-05016-0H
30	R cover hole cap	9.8~19.6	1.0~2.0		9008A-PTS1-9000
31	Others	7.8~11.8	0.8~1.2		
32	Oxygen sensor	19.6~29.4	2.0~3.0		39450-LEA6-8000

4.3. Frame

No.	ITEM	TORQUE		Remarks	DWG No.
		N-m	Kgf-m		
1	Steering				
	Nut STRG, Stem lock	58.8~68.6	6.0~7.0	---	90106-PUA3-B000-IN
	BOT, bridge (Fork pipe)	23.5~29.4	2.4~3.0	---	95801-08040-08G
	Stem lock	58.8~63.7	6.0~6.5	---	50306-IF96-C000
	Race nut (Head)	17.7~21.6	1.8~2.2	---	53220-LBA2
	Handle	49.0~58.8	5.0~6.0	---	94001-1008G-0S
2	Wheel				
	RR wheel axle nut	107.9~127.5	11.0~13.0	U-nut	90305-KKAK-C000
	FR wheel axle	14.7~24.5	1.5~2.5	---	44301-LEA7-C000
3	Suspension				
	FR fork bolt	19.6~25.5	2.0~2.6	---	96700-KED9-C000
	RR CUSH. upper	34.3~44.1	3.5~4.5	Flange bolt	95801-10040-07G
	RR CUSH. lower	34.3~44.1	3.5~4.5	Flange bolt	95801-10040-07G
4	Brake				
	FR caliper	29.4~39.2	3.0~4.0	---	90122-LEA7-C100
	RR caliper	29.4~39.2	3.0~4.0	---	90122-LEA7-C100
	Brake oil bolt	29.4~39.2	3.0~4.0	---	90145-9A61-C100
	Brake oil bolt (ABS-M)	29.4~39.2	3.0~4.0	---	90145-LFH1-E000
	M/C holder	9.8~13.7	1.0~1.4	Flange bolt	95701-06028-06
	M/C cap screw	1.2~2.0	0.12~0.2	---	93600-04012-IG
	C/P bleeder	3.9~6.9	0.4~0.7	---	43352-LBA2-C000 43352-KKD6-C000
	Disk bolt	31.4~37.3	3.2~3.8	---	90105-KCR3-C200 90105-LEA7-C100
	Modulator, ABS bolt	7.6~8.1	0.77~0.83	---	90113-LGE5-C100 90114-LGE5-C100
5	ENG. Hanger				
	Frame side	58.8~68.6	6.0~7.0	U-nut	90305-MAA1-C100
	ENG side	44.1~53.9	4.5~5.5	U-nut	90304-GHE8-C100
6	Muffler				
	EXH. Muffler	17.7~21.6	1.8~2.2	---	90033-GFY6-C000
	Muffler bracket/ RR fork	39.2~49.0	4.0~5.0	Flange bolt	90309-GFW0-9020-M1
7	Rear fork				
	RR fork/ ENG case	29.4~39.2	3.0~4.0	Flange bolt	95801-10075-07G
8	Others				
	SPDMT sensor cable	9.8~13.7	1.0~1.4	---	96001-06012-06
	IGN coil	9.8~13.7	1.0~1.4	---	94050-06080
	Oxygen sensor	19.6~29.4	2.0~3.0	---	---
	Main stand	29.4~39.2	3.0~4.0	U-nut	90304-LEA1-C000
	Fuel pump	2.7~4.1	0.28~0.42	Flange bolt	95701-LDF2-8000
	RR carrier	19.6~27.5	2.0~2.8	---	90106-KKC4-9000
	Start relay	2.5~3.4	0.25~0.35	---	94050-06080

5. Special Tool

Tool Name	Tool No.	Performance	Photo
Flywheel Puller	A120E00003	A.C. generator flywheel removal	
Tappet Adjuster	A120E00012	Tappet adjustment	
Oil Seal & Bearing Installer	A120E00014	Oil seal & bearing installing	
Flywheel Holder	A120E00021	A.C. generator flywheel holding	
#41 Nut & Fitting	A120E00028	Clutch disassembly & assembly	
Thread Protector	A120E00029	Protecting the crankshaft's thread	
Valve Cotter Installer	A120E00051	Valve cotter installation	
Clutch Spring Compressor	A120E00053	Clutch disassembly & assembly	
Shaft Collar Puller	A120E00088	Bearing crankcase removal	
Shaft Collar Driver	A120E00091	Bearing crankcase removal	
Shaft Collar Installer	A120E00092	Bearing crankcase installation	
Bearing Puller	A120E00093	Bearing removal	
Lock Nut Socket Wrench	A120F00002	Steering stem removal or installation	
Electric Repair Kit	A120F00032	Fuel injection system diagnosis	

6. LUBRICATION POINTS-FRAME

The following is the lubrication points for the frame. Use grease for parts not listed. Apply engine oil or grease to cables and movable parts not specified. It will avoid abnormal noise and damage the durability of the motorcycle.

 : Grease

 : Engine Oil

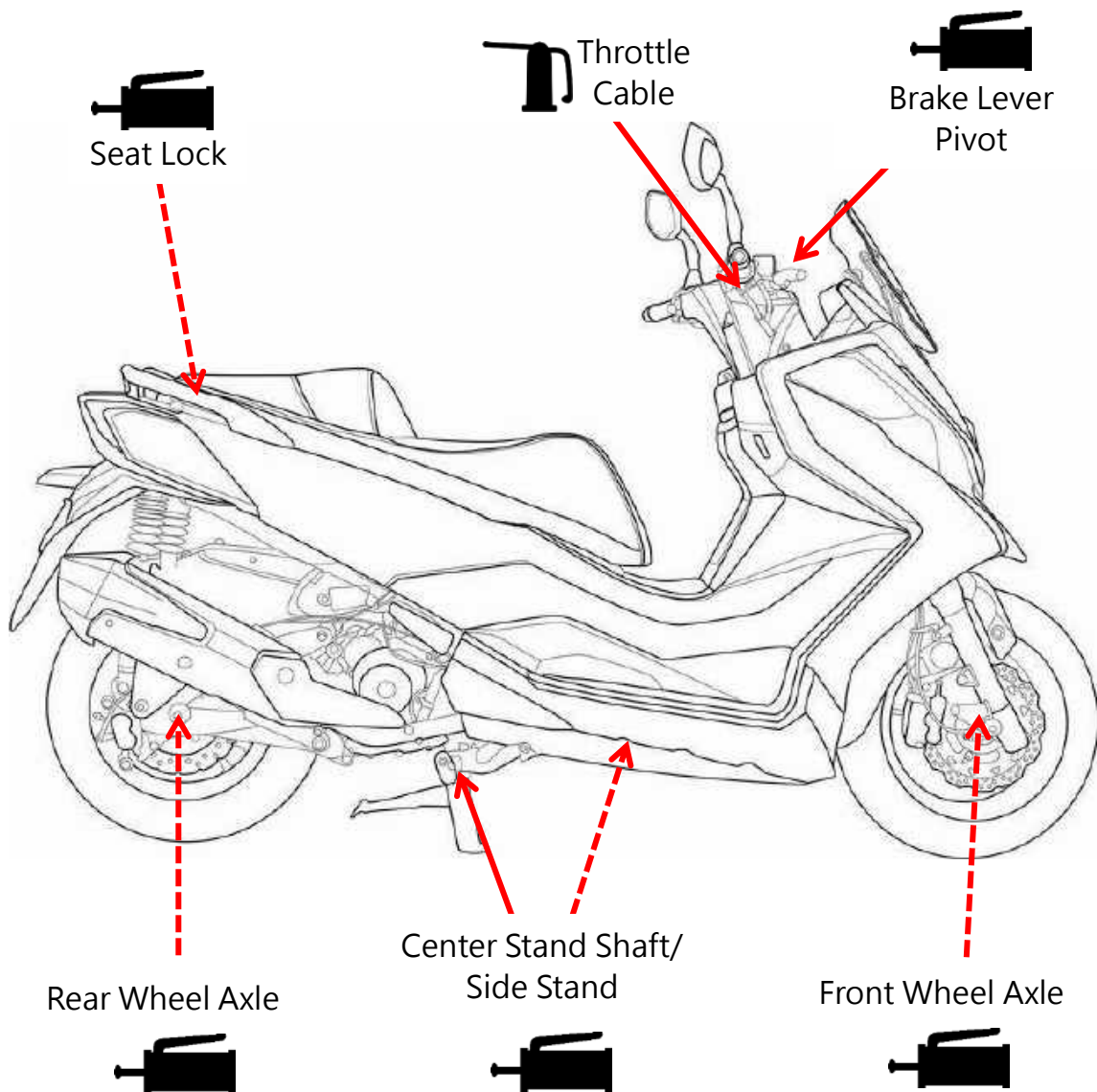

7. Components Location

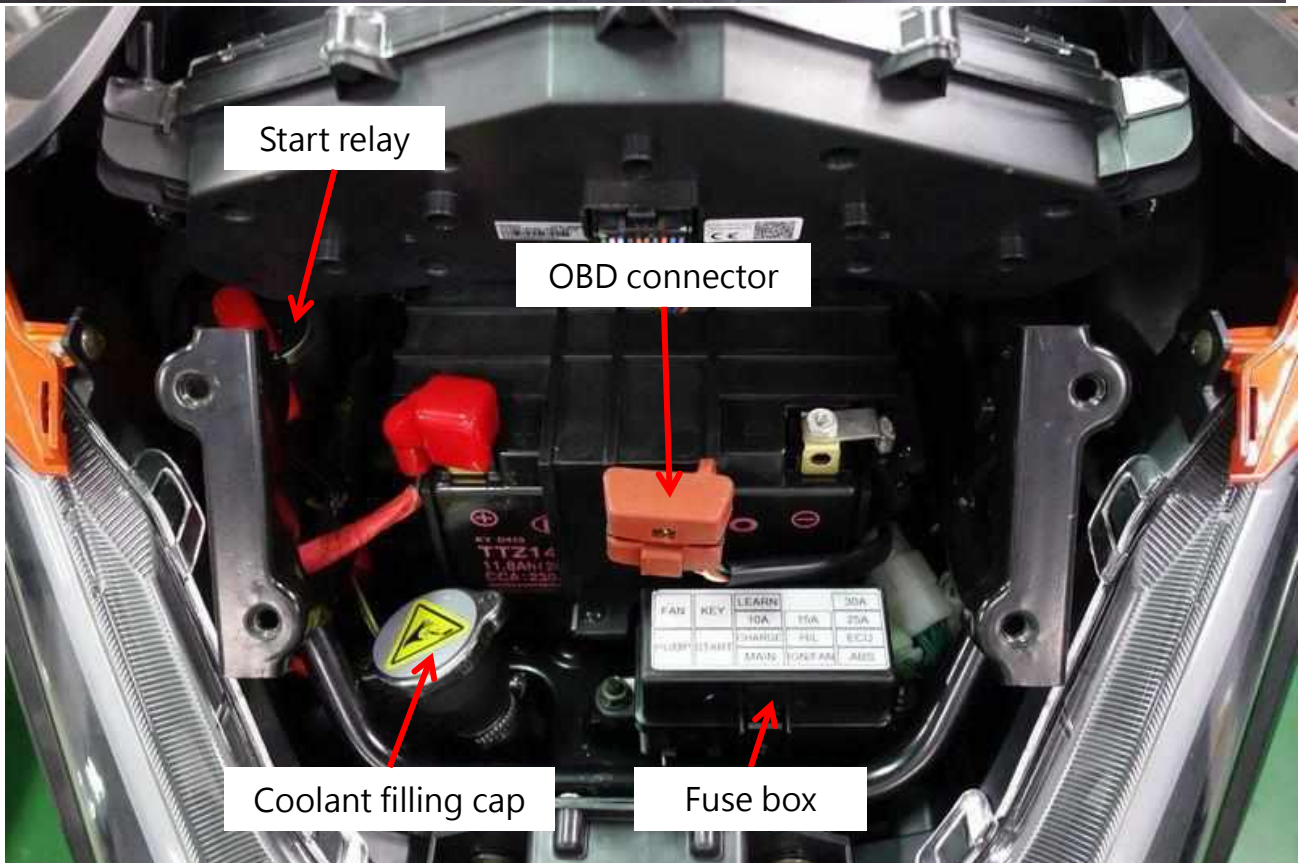
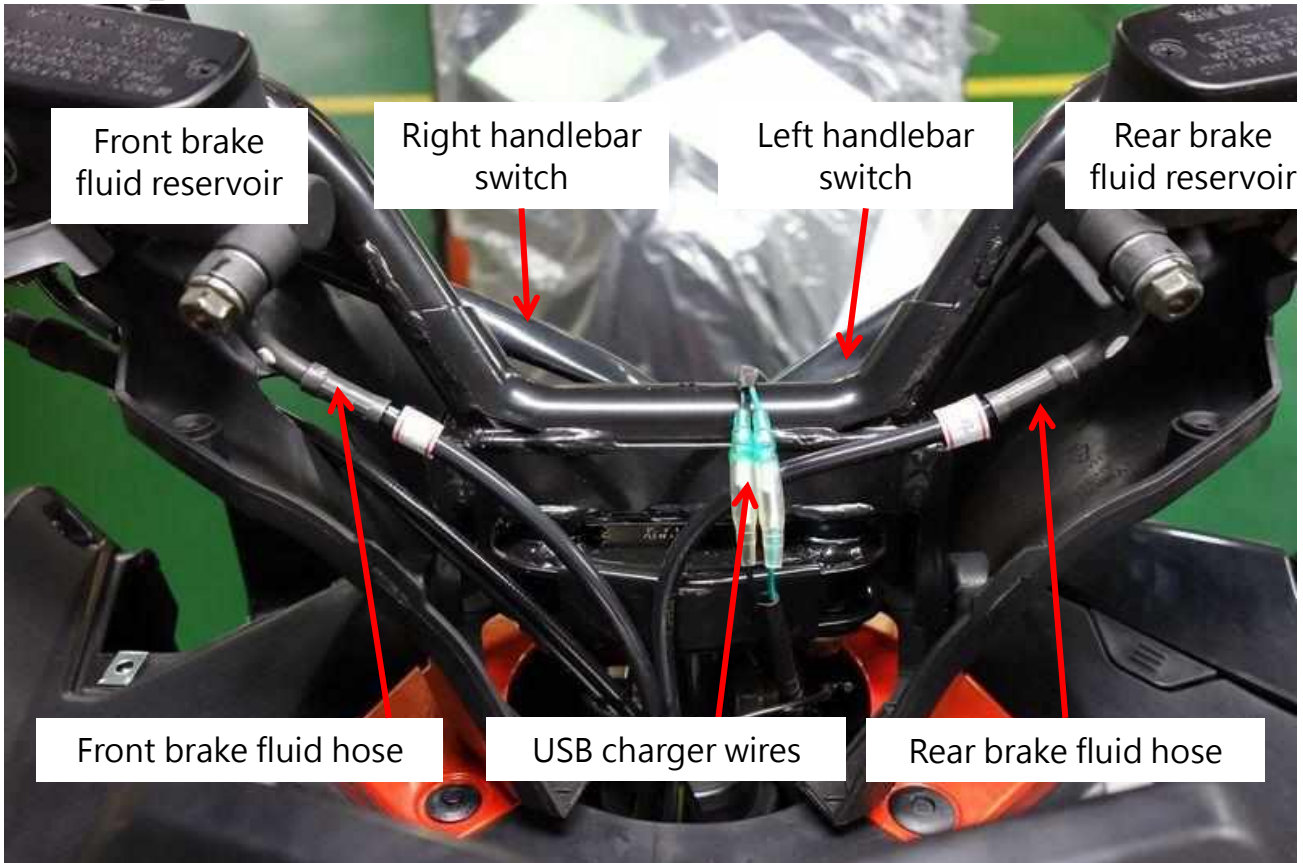

1. Quick Reference

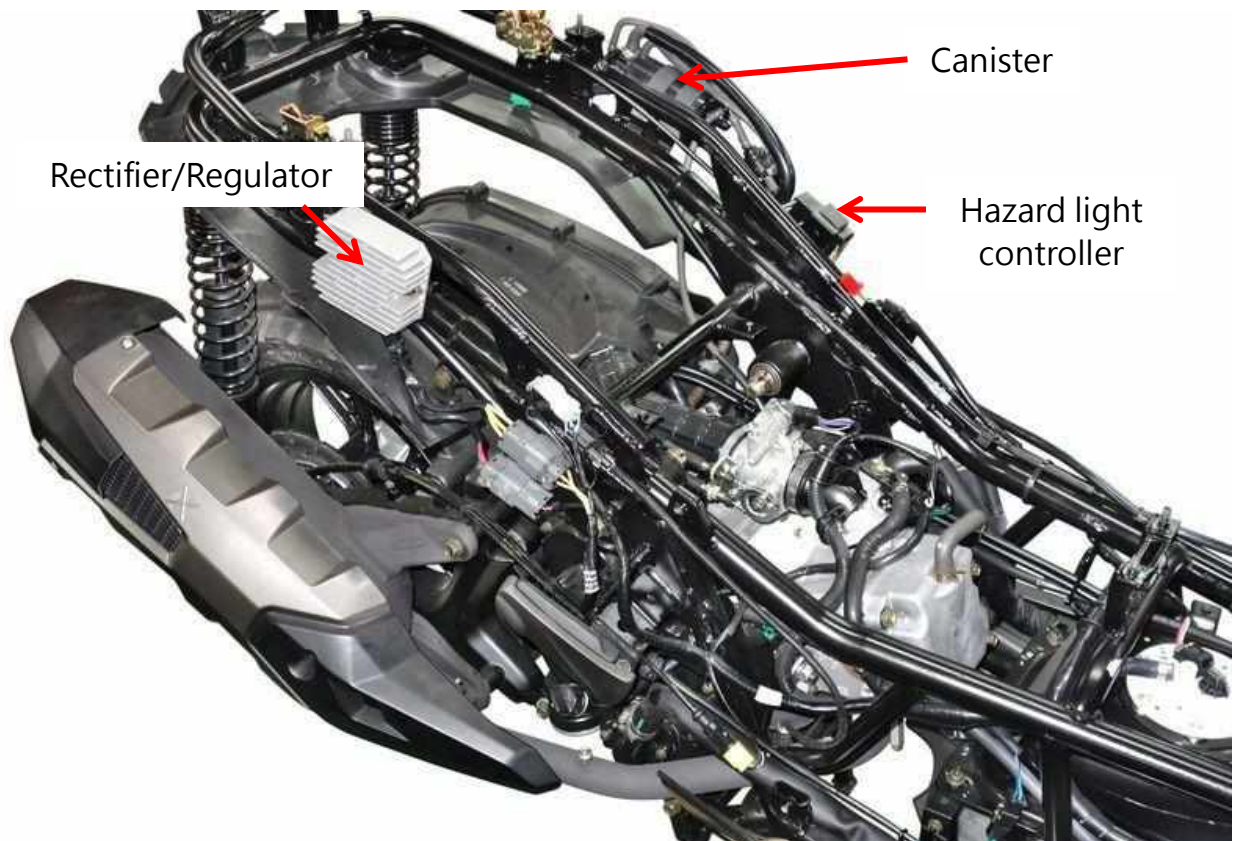
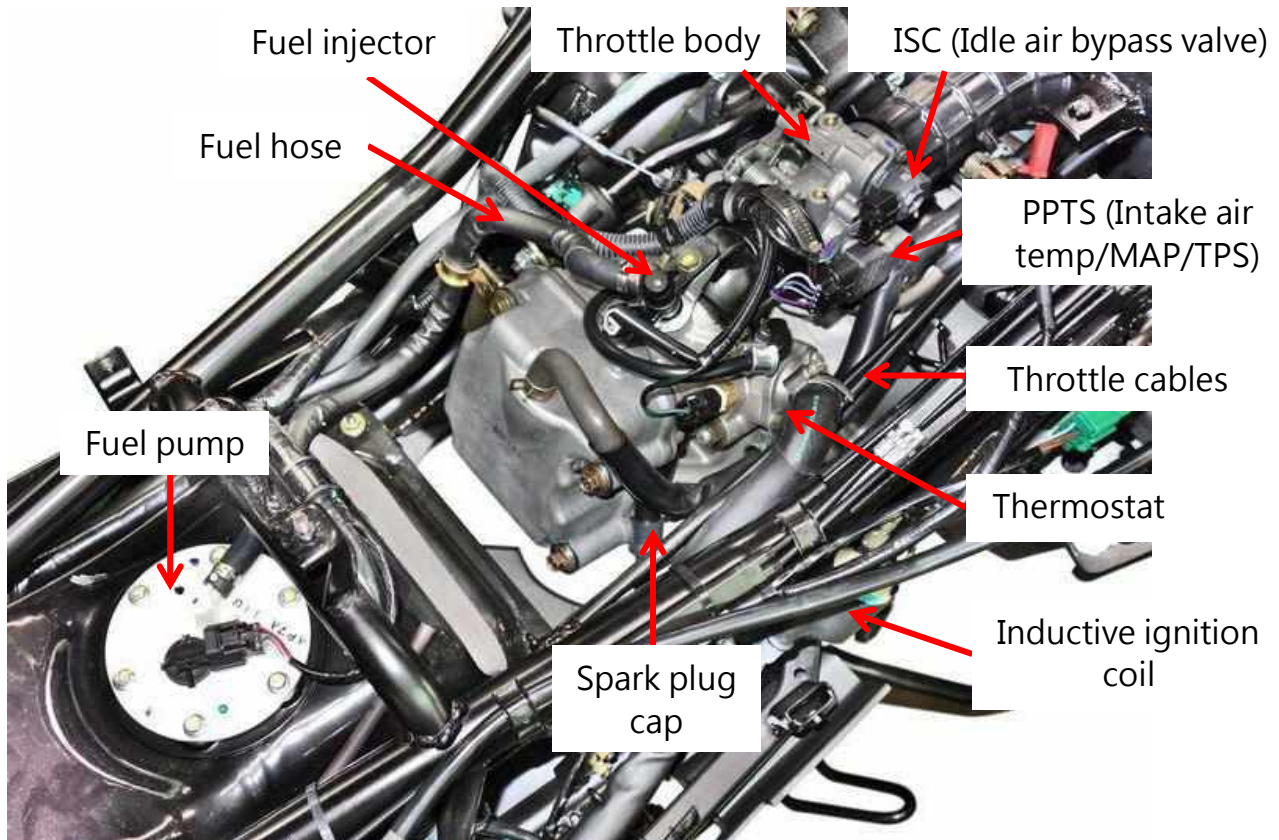

1. Quick Reference

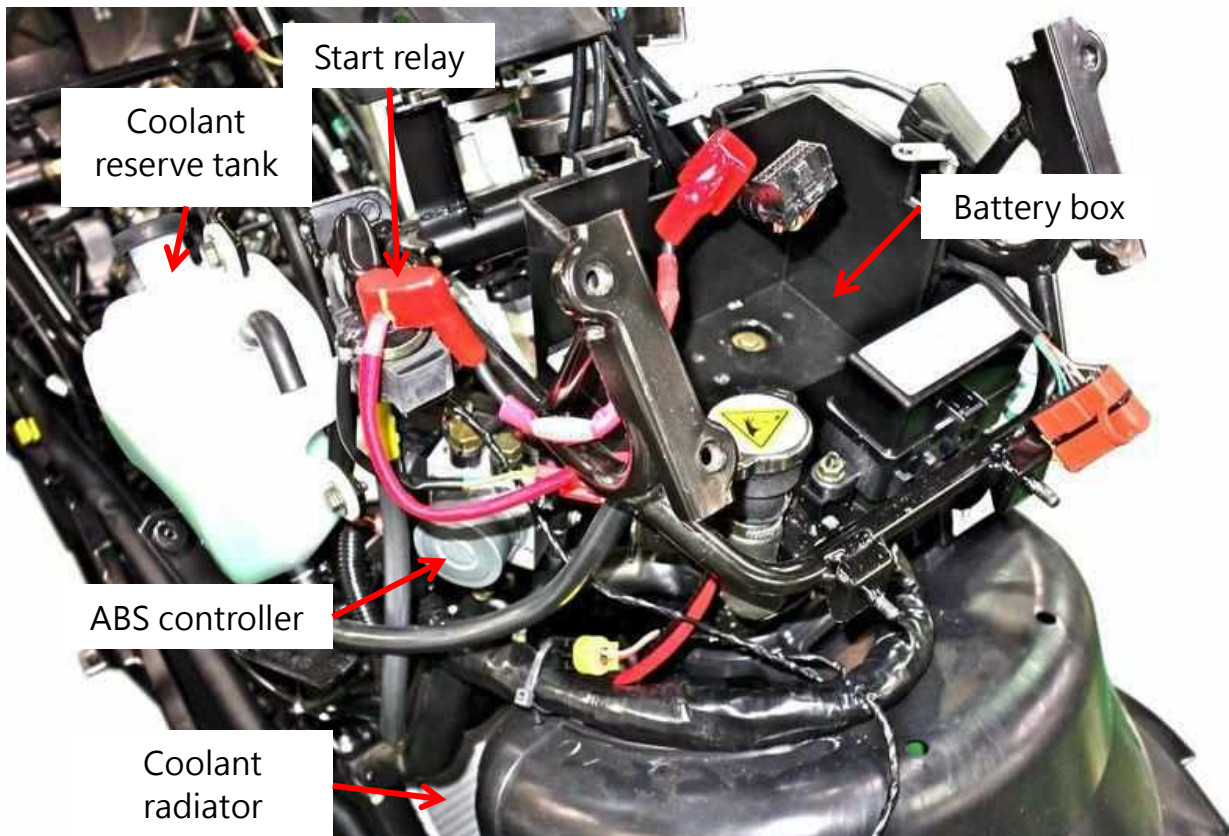
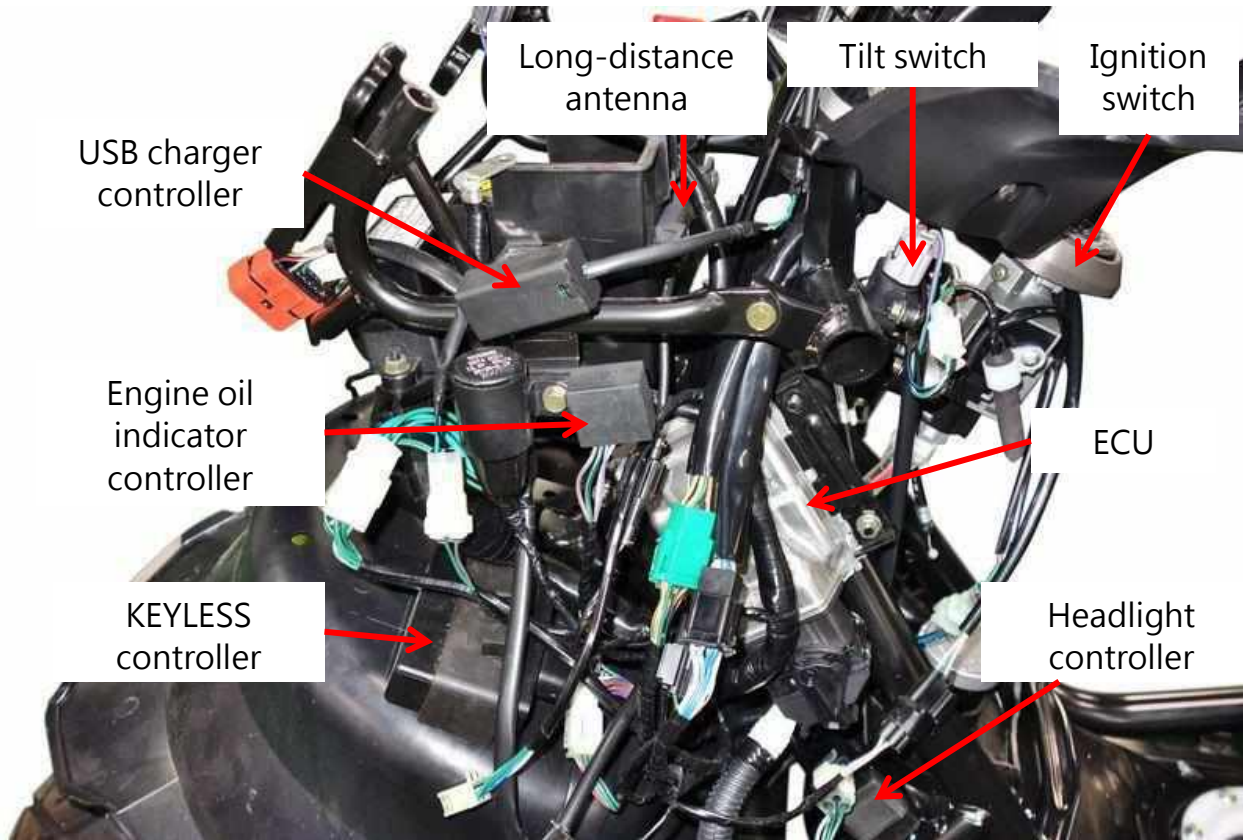

8. General Troubleshooting

8.1. Engine lacks power

Possible Causes

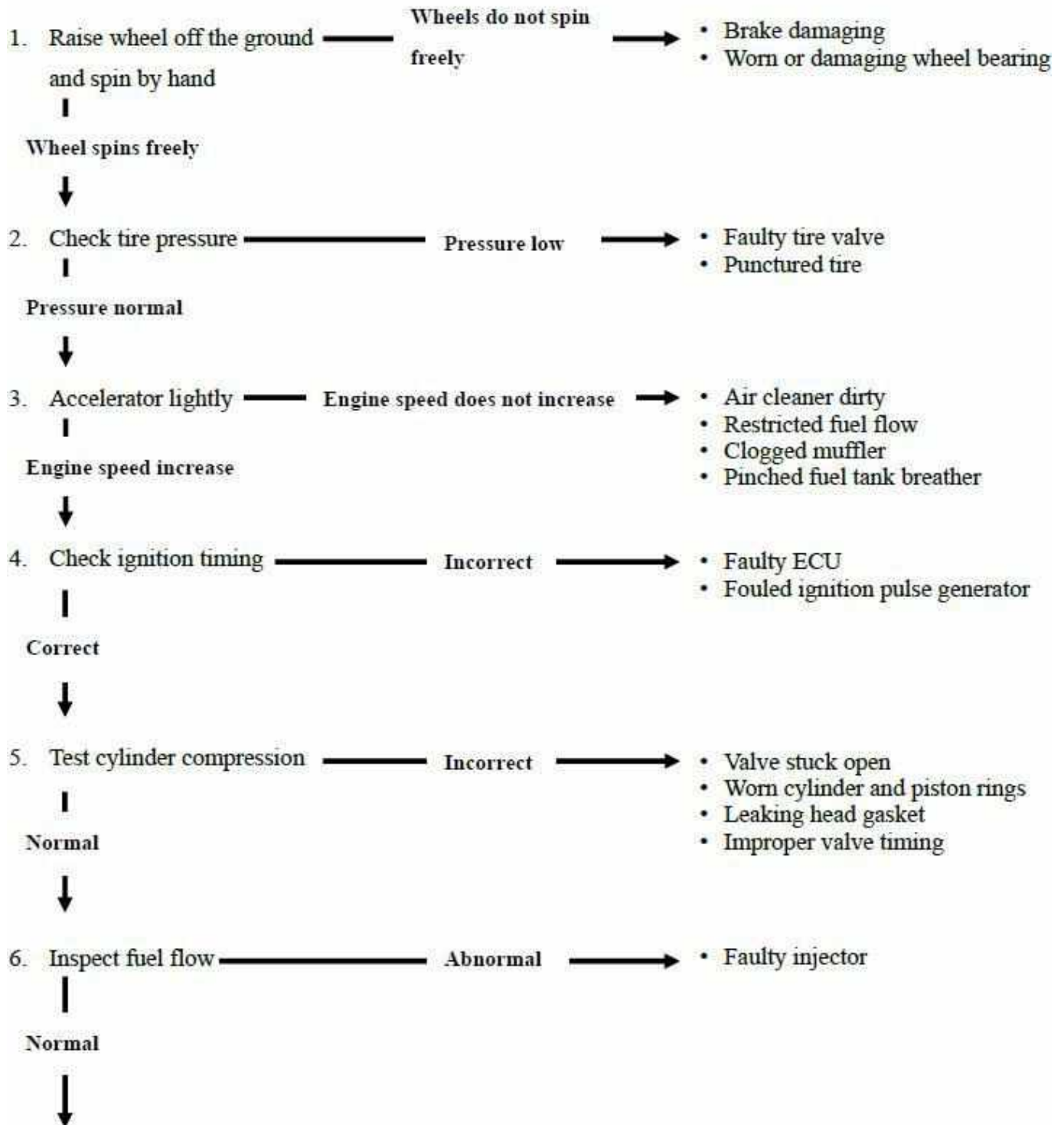

1. Quick Reference

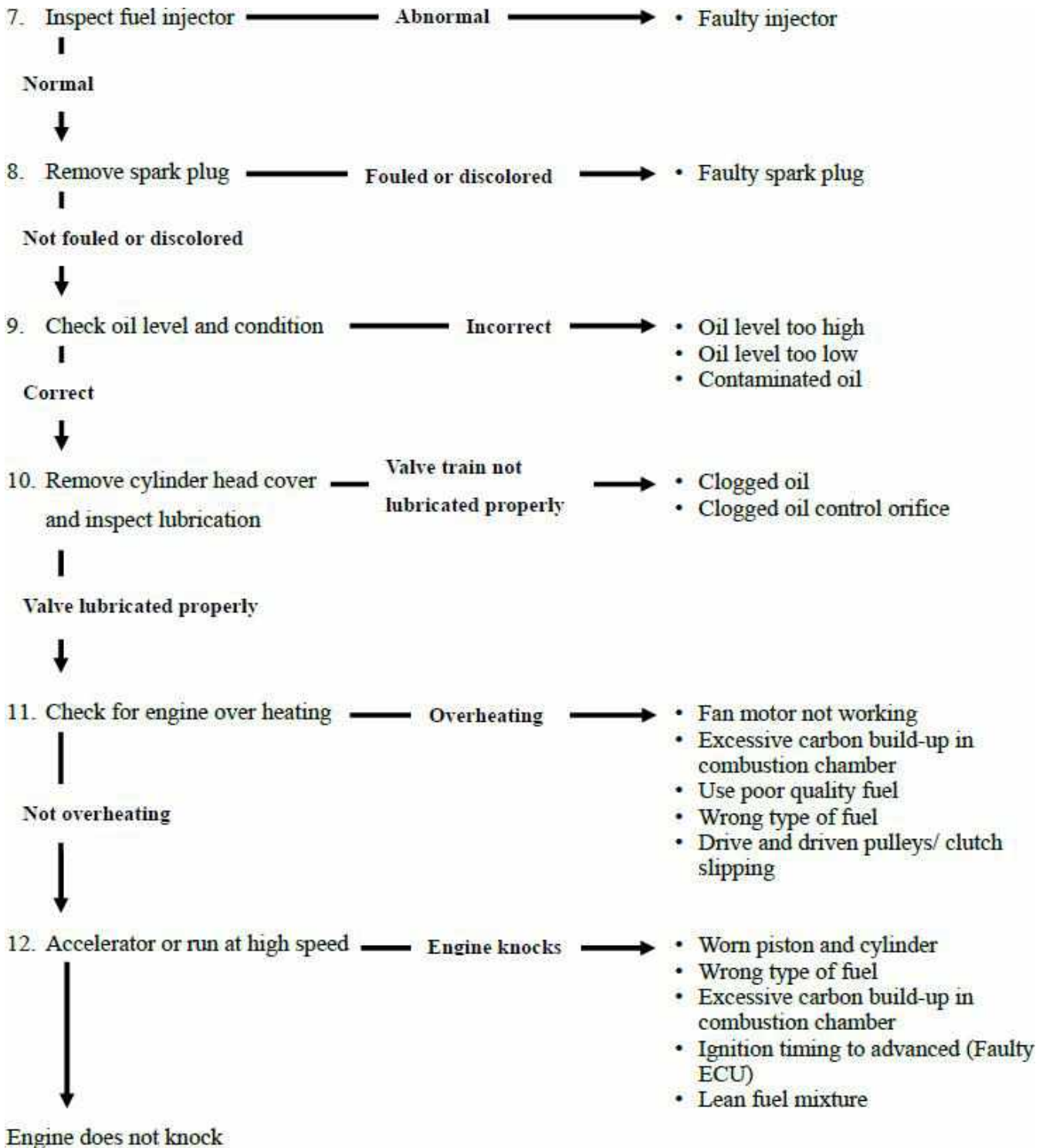

8.2. Engine will not start or is hard to start

Possible Causes

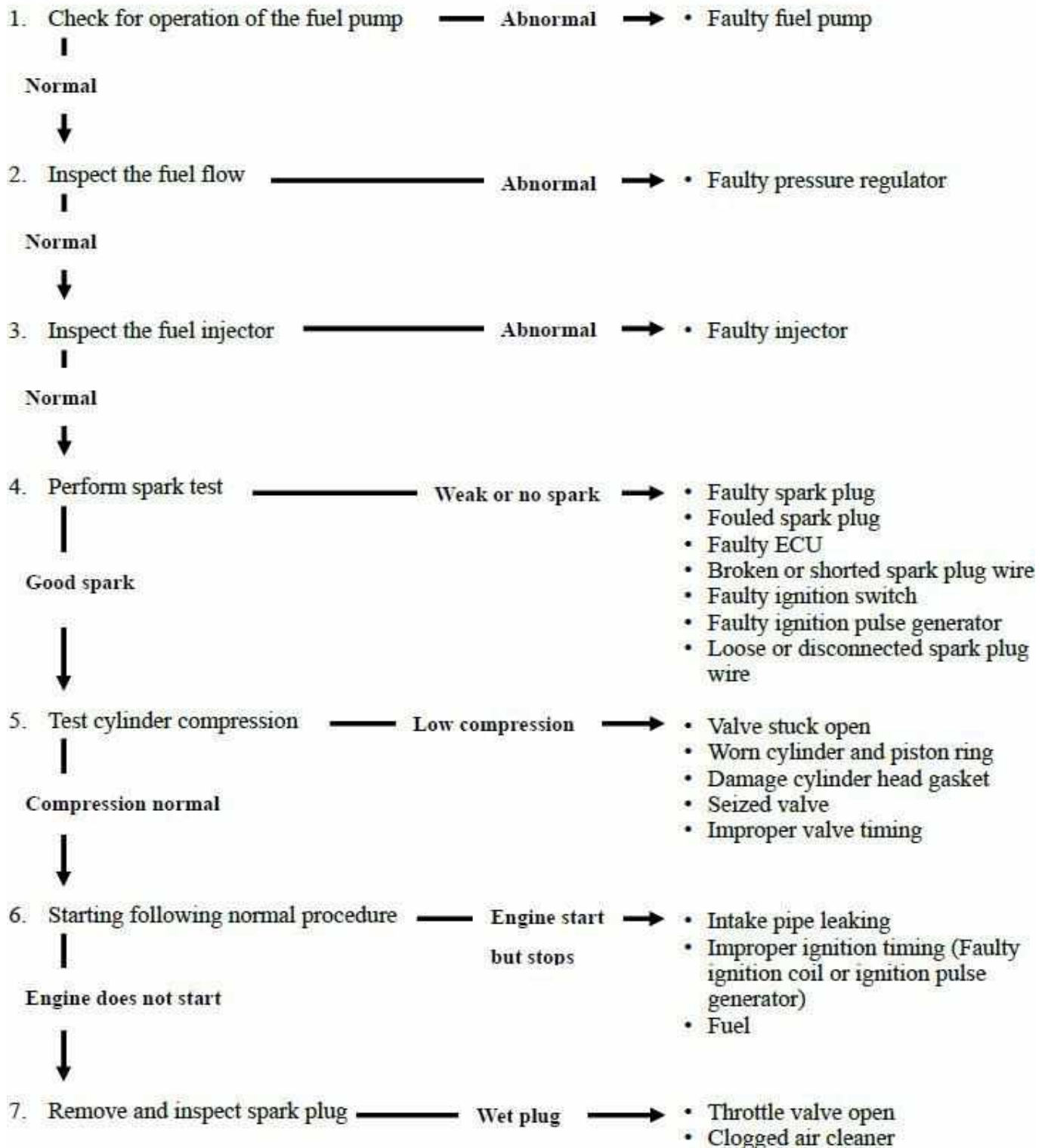

8.3. Poor handling

Possible Causes

1. If steering is heavy 
 - Steering stem adjusting nut too tight
 - Damaged steering head bearings

2. If either wheel is wobbling 
 - Excessive wheel bearing play
 - Bent rim
 - Improper installed wheel hub
 - Swing arm pivot bearing excessively worn
 - Bent frame

3. If the motorcycle pulled to one side 
 - Faulty shock absorber
 - Front and rear wheel not aligned
 - Bent fork
 - Bent swing arm
 - Bent axle

8.4. Poor performance at high speed

Possible Causes

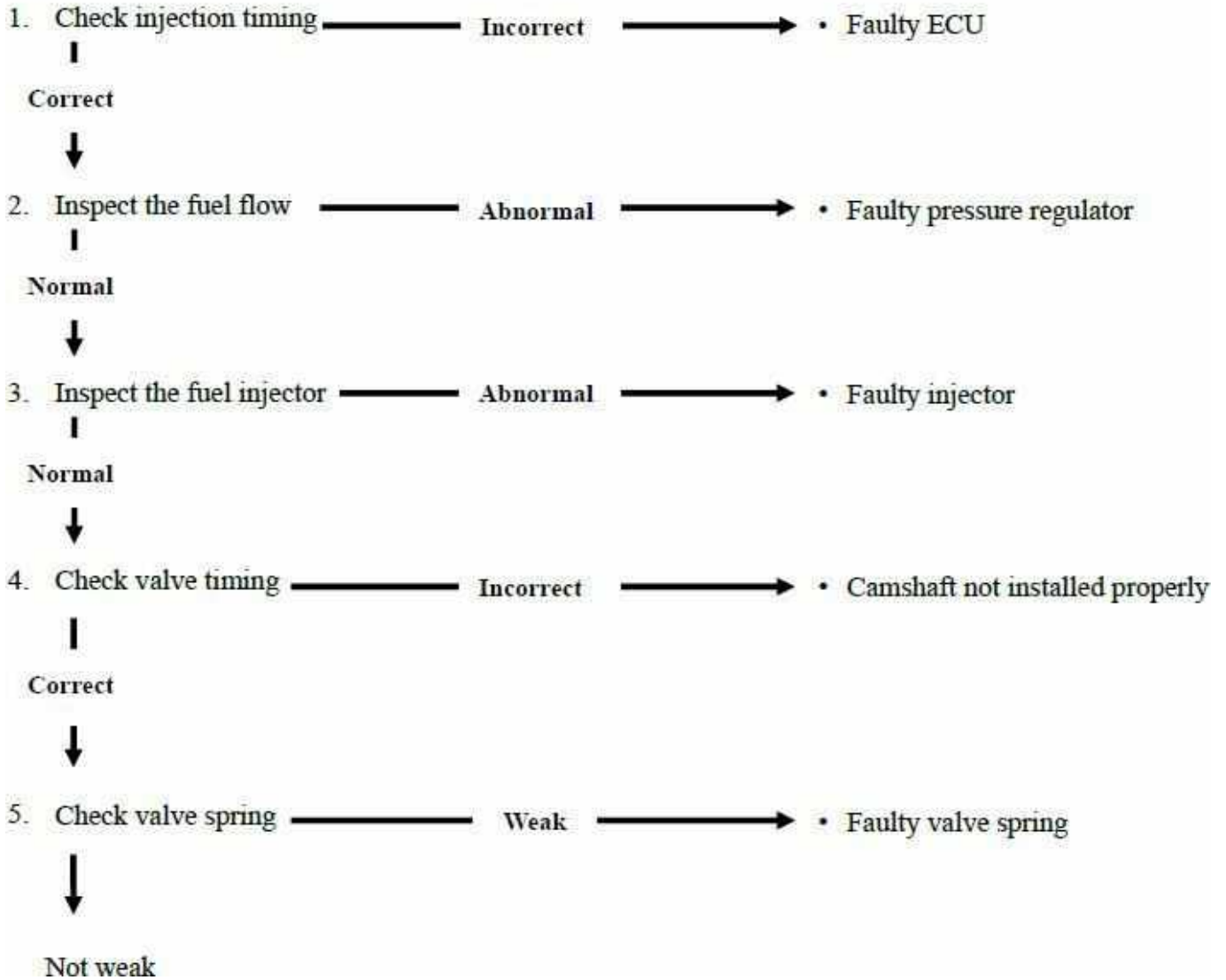

8.5. Poor performance at low and idle speed

Possible Causes

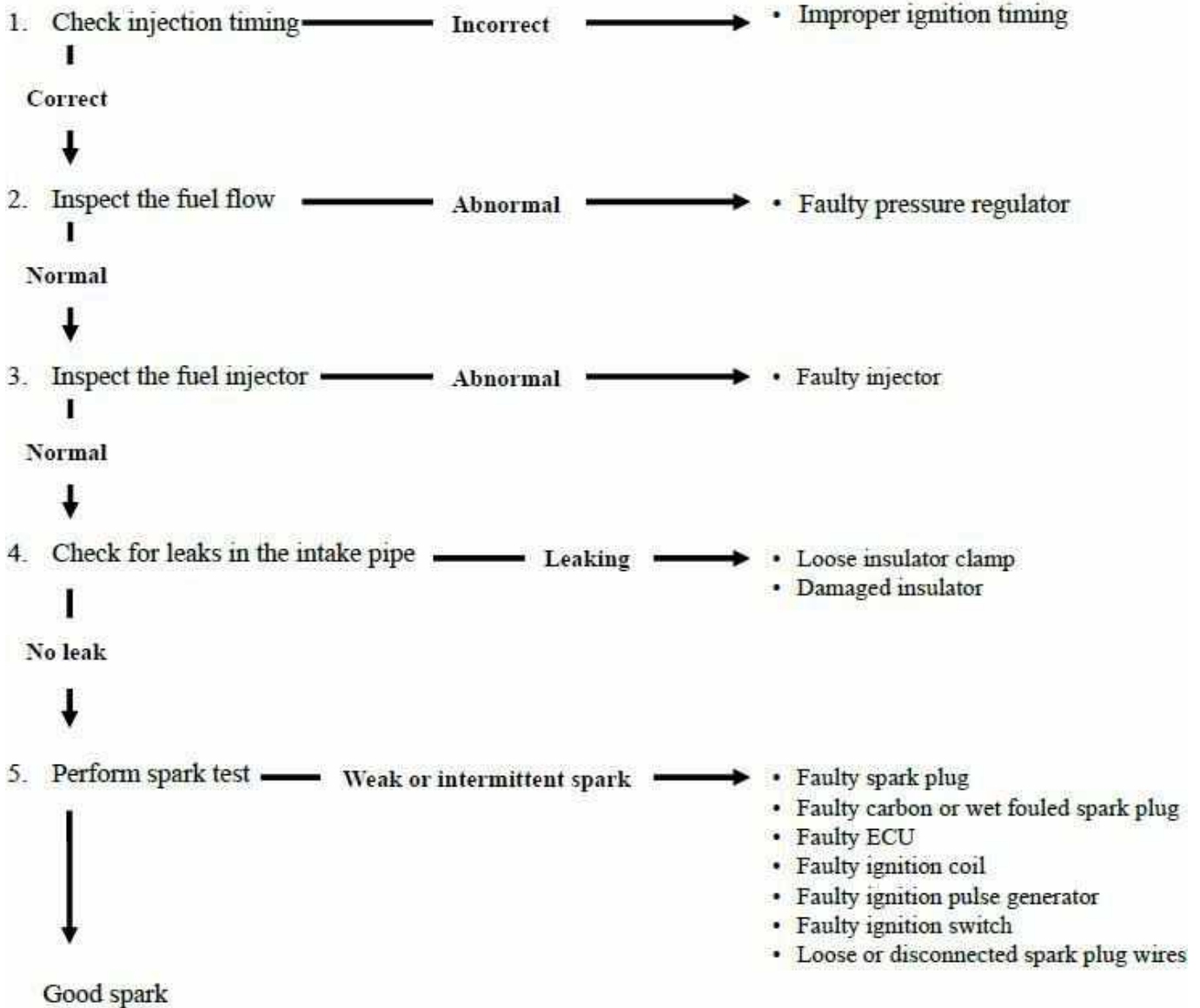

2. External components, Exhaust pipe

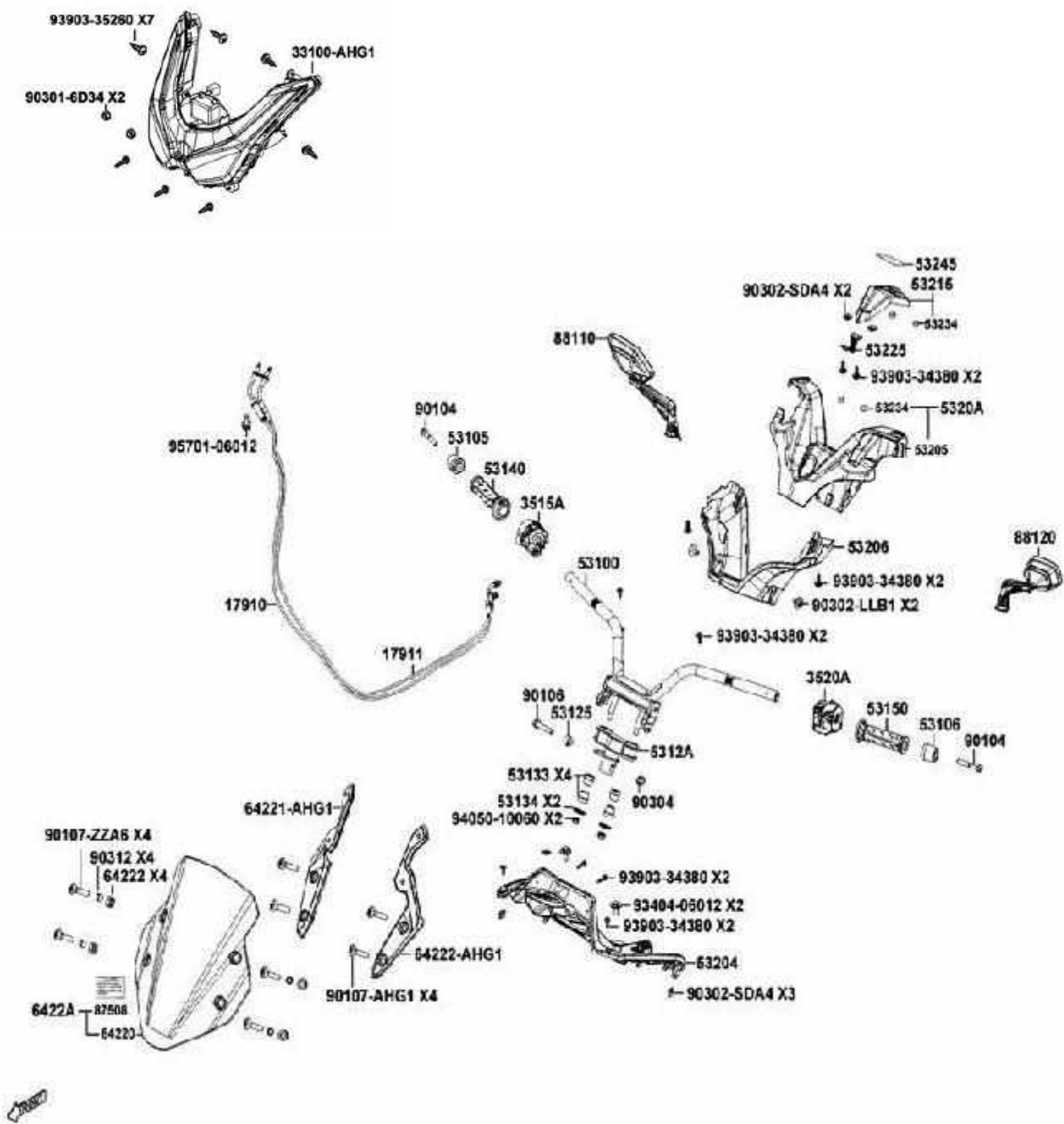

2

2. External components, Exhaust pipe

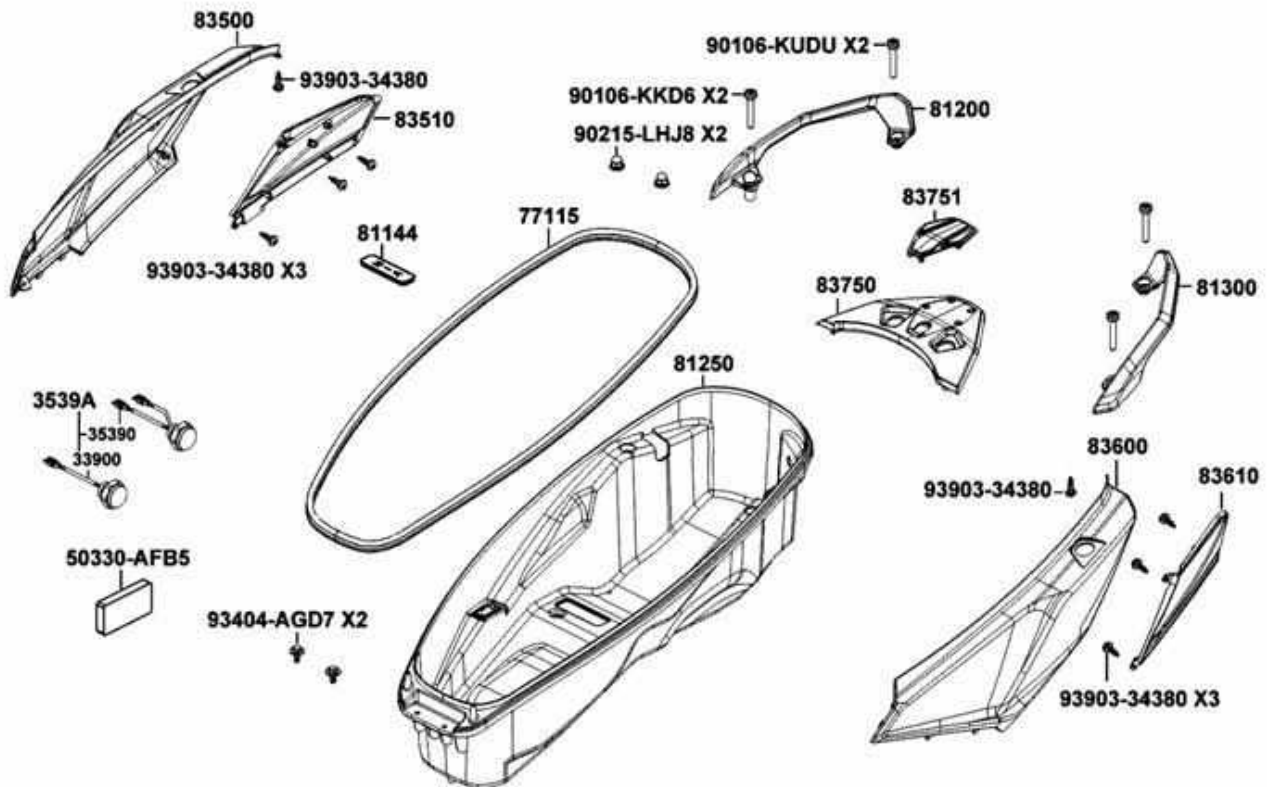
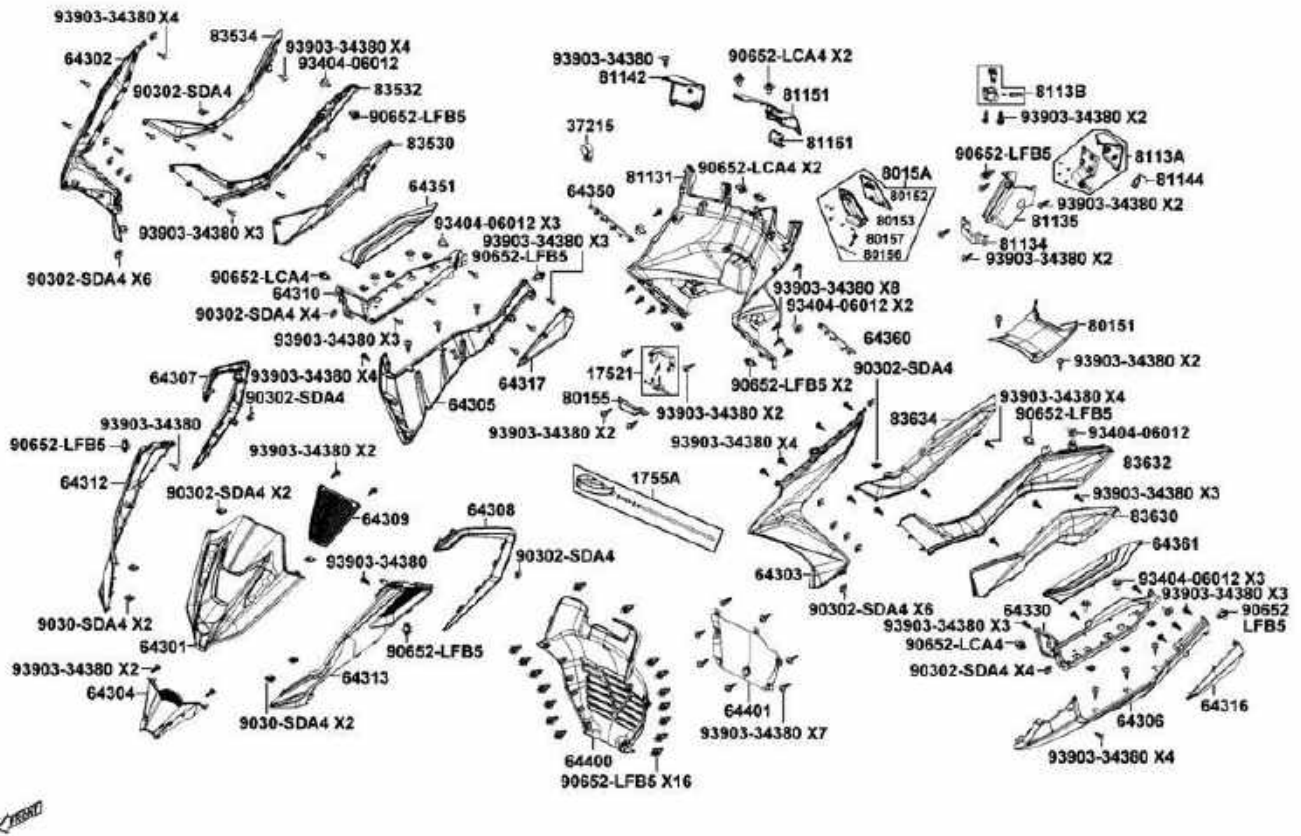

1.	Service Information.....	3
1.1.	General Instructions.....	3
1.2.	Torque value	3
1.3.	Troubleshooting	3
2.	External Components Removal.....	4
2.1.	Wind screen.....	4
2.2.	Front cover.....	4
2.3.	Headlight assy	4
	Side covers.....	5
2.4.	Seat	6
2.5.	Luggage box	6
2.6.	Rear carriers.....	6
2.7.	Center cover	6
2.8.	Tail light assy.....	7
2.9.	Floor panel assy.....	7
2.10.	Meter cover	8
2.11.	Leg shield	10
2.12.	Handlebar covers.....	10
2.13.	Front fender.....	11
2.14.	Rear fenders	11
2.15.	Undercover.....	12
2.16.	Muffler cover.....	12
3.	Exhaust assembly.....	13
3.1.	Muffler	13
3.2.	Exhaust pipe	13

1. Service Information

1.1. General Instructions

- When removing frame covers, use care not to pull them by force because the cover joint claws may be damaged.
- Make sure to route cables and harnesses according to the Cable & Harness Routing.

1.2. Torque value

Item	Torque (kgf·m)	Remarks
Exhaust pipe fixing bolts (tighten on the rear fork)	4.0~5.0	
Exhaust pipe front end nuts	1.8~2.2	
Other bolts on the exhaust pipe	1.8~2.2	
O2 sensor	2.0~3.0	

1.3. Troubleshooting

Excessive exhaust noise

- Broken exhaust system
- Exhaust gas leaks

Poor performance

- Deformed exhaust system
- Clogged muffler
- Exhaust gas leaks

2. External Components Removal

2.1. Wind screen

Remove the bolts and Allen bolts.

Remove the wind screen and brackets.

Install in the reverse order of work.



2.2. Front cover

Remove the plastic screws.

Remove the screws.

Remove the front cover.

Install in the reverse order of work.



2.3. Headlight assy

Remove the wind screen.

Remove the front cover.

Remove the nuts.



2. External components, Exhaust pipe



Remove the screws on each side of cover.



Remove the leg shields mat and floor mats on each side of cover.

Remove the screws.

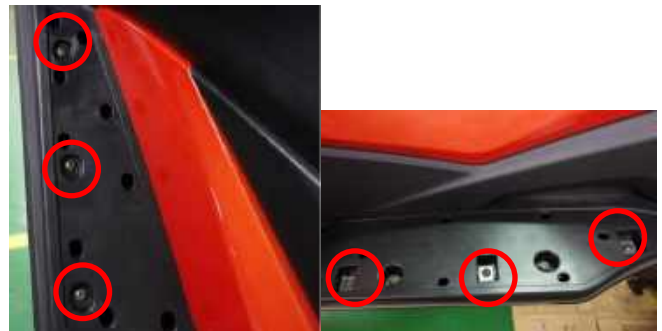

Side covers

Remove the plastic screws on each side of the under cowl.

Remove the plastic screw on rear part of the side cover. Repeat the process on the other side cover.

Remove the side covers.



Remove the screws on each side.

Remove the headlight assy.

Install in the reverse order of work.



2.4. Seat

Open the seat.

Remove the nuts.

Remove the seat.

Install in the reverse order of work.

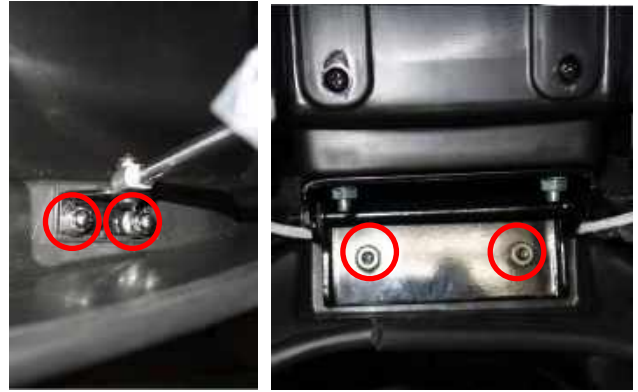

2.5. Luggage box

Remove the bolts and nuts.

Disconnect the luggage box light connector.

Remove the luggage box.

Install in the reverse order of work.



2.6. Rear carriers

Remove the Allen bolts on the each rear carrier.

Remove the rear carriers.

Install in the reverse order of work.



2.7. Center cover

Remove the plastic screws.

Pull the center cover back and up to remove it.

Install in the reverse order of work.

※ Do not damage the joint claws when removal.



2.8. Tail light assy

Remove the center rubber cover.

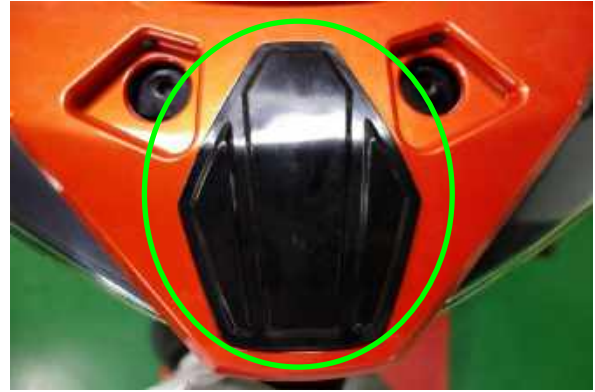

Remove the bolt.



Remove the plastic screws on the upper and down side of each side cover.

Disconnect all connectors of tail light assy.

Remove the tail light assy.

Install in the reverse order of work.

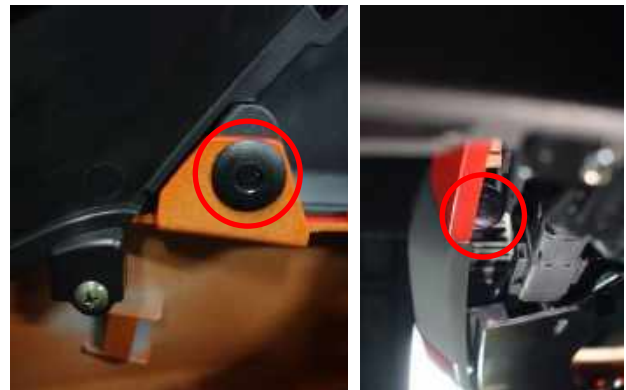

2.9. Floor panel assy

Remove the upper and lower bolts on the each side.



Remove the bolts on each side of floor panels.



Remove the plastic screw on each side of the leg shield.

Remove the floor panel assy.

Install in the reverse order of work.



2.10. Meter cover

Remove the wind screen.

Remove the front cover.

Remove the headlight assy.

Remove the plastic screws.



Remove the screw on each side of the meter cover.



2. External components, Exhaust pipe



Loosen the screw of ignition switch cover.
Turn the cover counterclockwise.
Pull out the cover but do not over pull it.
Disconnect the connector.

Remove the ignition switch cover.



Use a proper tool to pry out the lid.
Remove the key cover.

Lid Key cover



Remove the bolts.



Remove the plastic screw on each side of the meter cover.
Disconnect the connector of the meter.
Remove the meter cover.



2.11. Leg shield

Remove the bolt on each side of the cover.



Remove the cable of the fuel filling cap cover.
Remove the leg shield.

Install in the reverse of work.



2.12. Handlebar covers

Remove the bolts on each side of lower handlebar cover.



Disconnect the USB connector.
Remove the upper handlebar cover.

Remove the throttle cables.
Remove the screws on the lower handlebar cover.
Remove the lower handlebar cover.



Install in the reverse order of work.

※ Do not damage the joint claws during removal.

2.13. Front fender

Remove the Allen bolt and the bolt on each side of the front fender.

Remove the front fender.

Install in the reverse order of work.



2.14. Rear fenders

Remove the bolts on the lower rear fender.

Remove the lower rear fender.

Remove the bolts on the upper rear fender.

Remove the bolt on each side of the upper rear fender.

Remove the upper rear fender.

Install in the reverse order of work.

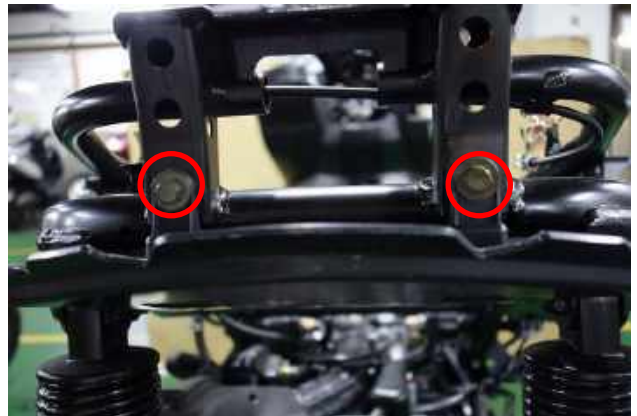

2.15. Undercover

Remove the bolts on each side of the undercover.

Remove the undercover.

Install in the reverse order of work.



2.16. Muffler cover

Remove the bolts.

Remove the muffler cover.

Install in the reverse order of work.

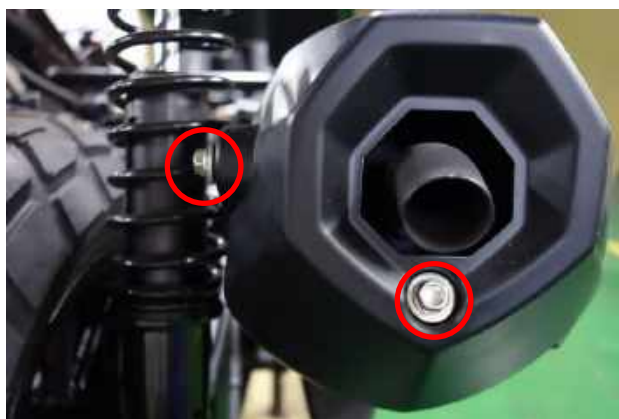

3. Exhaust assembly

3.1. Muffler

Remove the Allen bolt.

Remove the bolts.

Remove the muffler

Install in the reverse order of work.



3.2. Exhaust pipe

Remove the muffler.

Disconnect the O2 sensor connector.

Remove the nuts on the front end of the exhaust pipe.

Remove the gasket.

Install in the reverse order of work.

※ **Replace a new gasket after remove the exhaust pipe.**

Torque value

Item	Torque value
Front end nuts	1.8~2.2 kgf·m
Bolts	4.0~5.0 kgf·m
Allen bolt	1.8~2.2 kgf·m
O2 sensor	2.0~3.0 kgf·m

※ **Do not damage the O2 sensor and twist the cable.**

※ **Tighten the O2 sensor to the specific value to prevent water infiltration.**

Nuts



Gasket



O2 sensor

Periodic Maintenance

1.	Service Information	3
1.1.	Warning	3
1.2.	Specifications	3
2.	Maintenance Schedule	4
2.1.	Irregular Maintenance	5
2.2.	Notes	5
3.	Fuel Line	6
4.	Throttle Operation	6
5.	Air Cleaner	7
6.	Spark Plug.....	7
7.	Valve Clearance	8
7.1.	Inspection	8
7.2.	Adjustment.....	9
8.	Cylinder Compression	9
9.	Engine Oil.....	10
9.1.	Engine oil recommendation	10
9.2.	Engine oil level check	10
9.3.	Engine oil replacement	11
9.4.	Oil strainer screen clean	12
9.5.	Oil filter replacement	13
10.	Transmission Oil.....	15
10.1.	Oil change.....	15
11.	Idle Speed	16
12.	Drive Belt.....	16
13.	Clutch Shoe Wear	16
14.	Headlight Aim	17
15.	Coolant.....	17
15.1.	Inspection.....	17
15.2.	Add coolant	17
15.3.	Coolant recommendation	18
16.	Brake.....	19

16.1.	Brake fluid	19
16.2.	Brake pad wear	19
16.3.	Brake levers	20
17.	Nuts/Bolts/Fasteners	20
18.	Wheels/Tires	21
18.1.	Tire pressure.....	21
19.	Steering Handlebar	21
20.	Suspension	22
20.1.	Rear suspension adjustment	22
21.	Side Stand.....	23
21.1.	Functional check:	23

1. Service Information

1.1. Warning

- Before running the engine, make sure that the working area is well-ventilated. Never run the engine in a closed area. The exhaust contains poisonous carbon monoxide gas which may cause death to people.
- Gasoline is extremely flammable and is explosive under some conditions. The working area must be well-ventilated and do not smoke or allow flames or sparks near the working area or fuel storage area.

1.2. Specifications

Throttle Grip Free Play	2~6 mm	
Spark Plug	NGK: CPR7EA	
Spark Plug Gap	0.7~0.8 mm	
Valve Clearance	IN: 0.1 mm	EX: 0.1 mm
Idle Speed	1700±100 rpm	
Cylinder Compression	15±2 kgf/cm	
Engine Oil	Type	15-40W
	Capacity	At disassembly : 1.2 L
		At change : 1.0 L
Gear Oil Capacity	Type	#90
	Capacity	At disassembly : 0.13 L
		At change : 0.12 L
Coolant Capacity	Total: 1360 cc	Radiator and hoses: 870 cc
		Reserve tank: 490 cc
Ignition Timing	ECU control	

Tire

	1 Rider (60 kg)	2 Riders (120 kg)
Front	2.0 kgf/cm ²	2.0kgf/cm ²
Rear	2.25 kgf/cm ²	2.25 kgf/cm ²

Tire specification

Front	120/80-14 58S
Rear	150/70-13 64S

Torque values

Front axle	2.0 kgf-m
Rear axle nut	12 kgf-m

2. Maintenance Schedule

Perform the pre-ride inspection at each scheduled maintenance period. This interval should be judged by odometer reading or months, whichever comes first.

I: INSPECT AND CLEAN, ADJUST, LUBRICATE OR REPLACE IF NECESSARY

C: CLEAN R: REPLACE T: Tighten M: Maintain D: Diagnostic

Item	Maintenance Operation Item	Maintenance Interval															
		It depends on the mileage or the month.		Mileage	300	1000	2000	3000	4000	5000	6000	7000	8000	9000	10000	11000	12000
		Month	First time	1	2	3	4	5	6	7	8	9	10	11	12		
Lubrication System	Engine Oil	★	R	R	R	R	R	R	R	R	R	R	R	R	R	R	
	Oil Screen	★	C		C			C						C			
	Oil Filter	★	R					R						R			
	Gear Oil	★	R			R				R			R			R	
Fuel System	Fuel Pump	★			I/C			I/C						I/C			
	Throttle Cable	★			I			I						I			
Air Supply System	Air Element	★	Note 3, 4			I			R		I			R		I	
	Activated Carbon Canister	★				I			I					I			
	CVT Filter Wool	★							R					R			
	PCV Evaporative Emission Control Valve	★				I			I					I			
	O2 Sensor	★				I			I					I			
Drivetrain	Cam Chain	★				I			I					I			
	CVT Driving Belt/Roller/Clutch Outer Sleeve	★				I			I			M		I			
	Rear Wheel Driving Belt	★	Note 2	I	I	I	I	I	I	I	I	I	I	I	I	I	
	Valve Clearance	★	Note 4			I			I					I			
Ignition System	Spark Plug	★				I								R			
	Ignition Circuit	★							I					I			
Engine Management System	Throttle Body	★	Note 4						M/I					M/I			
	Fuel Injector	★	Note 1,4			D/M			D/M		D/M			C		D/M	
	Idle Air Bypass Valve	★							D/M					D/M			
	Engine Temperature Sensor	★				D			D		D			D		D	
	Air Intake Pressure Sensor	★				D			D		D			D		D	
	Ignition Coil	★				D			D		D			D		D	
Brake System	Battery	★				D			D		D			D		D	
	Brake Lever Play			I	I	I	I	I	I	I	I	I	I	I	I	I	
	Brake Fluid	★		I	I	I	I	I	I	I	I	I	I	R	I	I	
	ABS Wheel Speed Sensor/Reading Disc	★							M/I					M/I			
Cooling System	Brake pad lining	★		I	I	I	I	I	I	I	I	I	I	I	I	I	
	Coolant Reservoir/ Coolant	★		I		I			I					I			
	Fin/Front Protection Screen of Radiator			I	I	I	I	I	I	I	I	I	I	I	I	I	
Others	Coolant hoses/Connector	★		I	I	I	I	I	I	I	I	I	I	I	I	I	
	Important Body Bolts	★		T	T	T	T	T	T	T	T	T	T	T	T	T	
Others	Tire Pressure/Tread			I	I	I	I	I	I	I	I	I	I	I	I	I	

2.1. Irregular Maintenance

1. Ignition System: if ignition failure, engine overheating or engine stalling problems are noticeable and occur constantly, perform maintenance and inspection.
2. Remove Carbon Deposits: If the horsepower of the engine decreases considerably, remove the carbon deposits in the valve, piston, throttle body, idle air bypass valve and fuel injector.
3. Drivetrain: If the top speed drops considerably, perform maintenance and inspection for the CVT parts and replace them when necessary.
4. Fuel Injector: Please remove the carbon deposits or gummy residues inside the fuel injector when the vehicle has not been operated for a long time.
5. Fin/Front Protection Screen of Radiator: Check and clean it every 1000 km. Perform cleaning and maintenance as early as possible if driving in dusty and rainy areas.
6. ABS Wheel Speed Sensor/Reading Disc: Perform maintenance and inspection every 5000 km. Replace the sensor when necessary.

2.2. Notes

1. We recommend that you add a bottle of KYMCO fuel injector cleaner every 1000 km to the fuel tank.
2. An air blow gun must be used to clean the dust and foreign objects inside the belt wheel for models with rear wheel driving belt. Check the belt for crack or fracture and replace it when necessary. Check whether the tension of belt is within the specification. Adjust it to the range within the specification when necessary.
3. If the vehicle is often running in dusty areas, clean and replace the air element more often for longer service life.
4. To ensure fuel efficiency and mechanical performance of the vehicle, be sure to perform cleaning and maintenance for fuel injector, throttle body, valve clearance and air filter based on the mileage (or month).
5. It is suggested that the maintenance item marked ★ must be performed by a KYMCO dealer.

3. Fuel Line

Check the fuel lines and replace any parts which show signs of deterioration, damage or leakage.

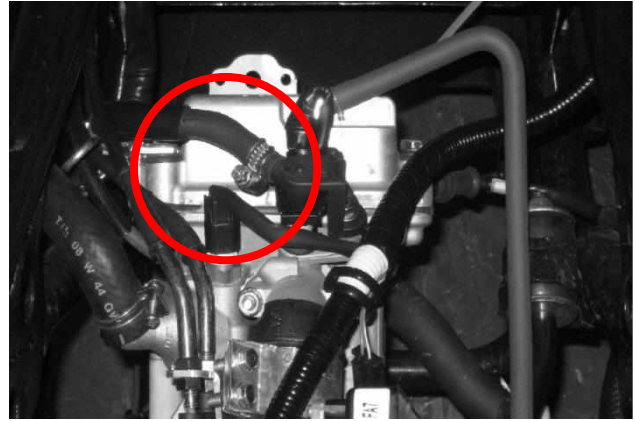

4. Throttle Operation

Check the throttle grip for smooth movement.

Measure the throttle grip free play.

Free Play: 2~6 mm

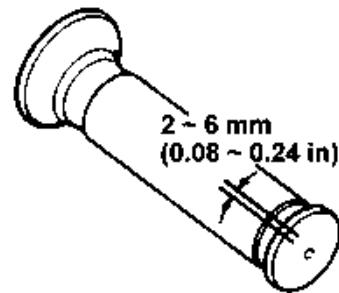

Major adjustment of the throttle grip free play is made with the adjusting nut at the throttle valve. Adjust by loosening the lock nut and turning the adjusting nut.

When the free play has been moved into specification hold the adjuster in place and tighten the locknut securely. Adjust the closing cable as needed for a proper throttle action.



Adjust nut

Lock nut

Minor adjustment is made with the adjusting nut at the throttle grip side.

Slide the rubber cover (1) out and adjust by loosening the lock nut (3) and turning the adjusting nut (2).

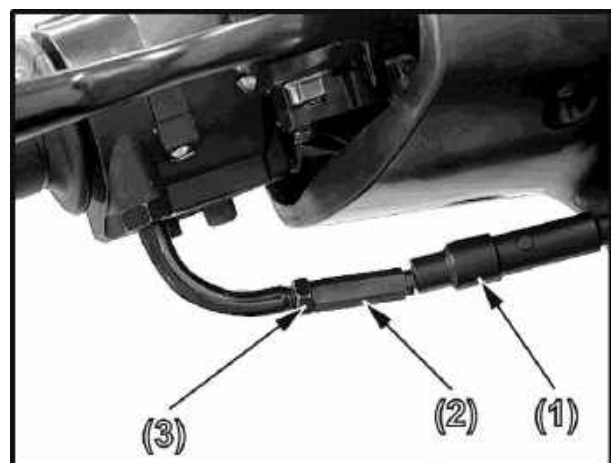

5. Air Cleaner

1. Remove the screws from the air cleaner cover, and then remove air cleaner cover.
2. Remove screws from the air cleaner element, then remove and discard this air cleaner element.
3. The new air cleaner element installation is in the reverse order of removal.

Use the KYMCO genuine air cleaner element or an equivalent air cleaner element specified for your model. Using the wrong KYMCO air cleaner element or a non-KYMCO air cleaner element which is not of equivalent quality may cause premature engine wear or performance problems.

※ **The air cleaner should be serviced at regular intervals. Service more frequently when riding in unusually wet or dusty areas.**



6. Spark Plug

Remove the spark plug cap and spark plug
Check the spark plug for wear and fouling deposits.

Clean any fouling deposits with a spark plug cleaner or a wire brush.



Specified Spark Plug: CPR7EA (NGK)

Measure the spark plug gap.

Spark Plug Gap: 0.7~0.8 mm

※ **When installing, first screw in the spark plug by hand and then tighten it with a spark plug wrench.**

Torque: 0.8~1.2 kgf-m (8~12 N-m)

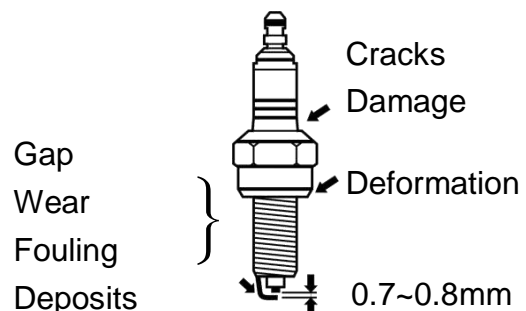

7. Valve Clearance

7.1. Inspection

※ **Inspect and adjust valve clearance while the engine is cold (below 35 °C).**

Remove the four bolts, and then remove cylinder head cover.



Remove the timing inspection cap from the right side of the engine with a large flat blade screwdriver. Inspect the O-ring on the cap and replace it as needed.

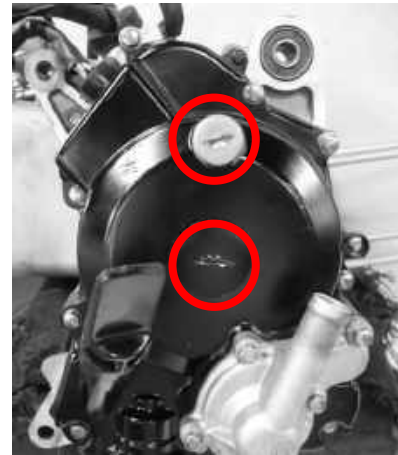

Turn the A.C. generator flywheel clockwise to the top dead center (TDC) on the compression stroke so that the "T" mark on the flywheel aligns with the index mark on the left crankcase cover.

The punch mark on the camshaft should face upward as shown.

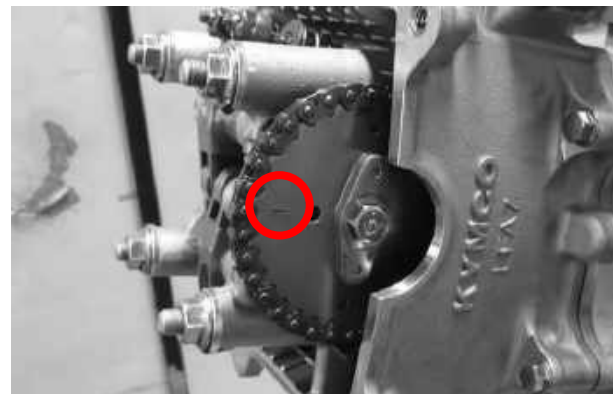

If the punch mark on the camshaft is facing downward, turn the crankshaft clockwise one full turn (360°) and the punch mark are facing upward.

Measure the valve clearance with a thickness feeler gauge. Insert the feeler gauge between the tappet adjusting screw and the valve stem. The clearance is correct when there is a light drag on the feeler gauge. The clearance is the same for the exhaust and intake valves. If the clearance is out of spec move on to the adjustment section.

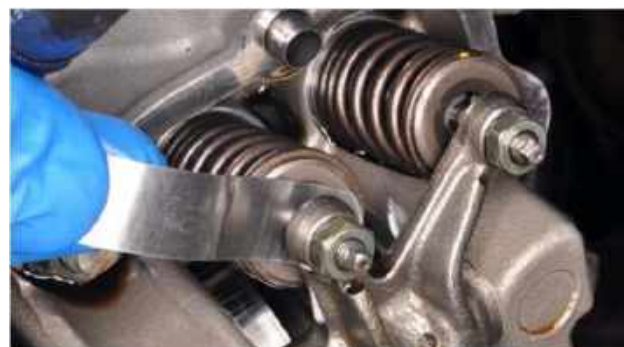

Valve Clearance: **IN: 0.1 mm**
 EX: 0.1 mm

7.2. Adjustment

Place a 9 mm box end wrench over the locknut, and loosen the locknut. If the valve clearance is tight back out the valve tappet adjusting screw with the tappet adjustment tool. If the clearance is too loose turn in the adjusting screw until there is a light drag on the feeler gauge. Hold the adjusting screw locknut in place with the wrench to make sure it doesn't interfere with the adjustment. Lubricate the tappet adjusting screw threads with fresh engine oil. Hold the adjuster in place and tighten the locknut. Always recheck the clearance after tightening the locknut. Also, recheck after turning the engine over and back to TDC on the compression stroke.

Install the removed parts in the reverse order of removal.

Make sure the O-rings on the crankshaft and timing plugs are in good condition.

Replace them as needed. Install the timing inspection and crankshaft caps to the right side of the engine. Tighten the caps securely but not overly with a large flat blade screwdriver.



Torque: 0.7~1.1 kgf-m

Special tool:

Valve adjuster A120E00012

8. Cylinder Compression

Warm up the engine before compression test.

Remove the center cover and spark plug cap. Remove the spark plug.

Insert a compression gauge.

Open the throttle valve fully and push the starter button to test the compression.

Compression: 15±2 kgf/cm²

If the compression is low, check for the following:

- Leaky valves
- Valve clearance too small
- Leaking cylinder head gasket
- Worn pistons
- Worn piston/cylinder

If the compression is high, it indicates that carbon deposits have accumulated on the combustion chamber and the piston head.

9. Engine Oil

9.1. Engine oil

recommendation

Use a premium quality 4-stroke motor oil to ensure longer service life of your scooter. Use only oils which are rated, SJ under the API service classification. The recommended viscosity is SAE 15-40W. If SAE 15-40W motor oil is not available, select an alternative according to the right chart.

Engine oil capacity:

At disassembly:

1.2 L (0.968 Imp qt, 1.166 US qt)

At change:

1.0L

9.2. Engine oil level check

Check the engine oil level each day before riding the scooter.

The level must be maintained between the upper and lower level marks on the oil filler cap/dipstick.

1. Start the engine and let it idle for a few minutes.
2. Stop the engine and put the scooter on its center stand on level ground.
3. After a few minutes, remove the oil filler cap/dipstick, wipe it clean, and reinsert the oil filler cap/dipstick without screwing it in. Remove the oil filler cap/dipstick. The oil level should be between the upper and lower marks on the oil filler cap/dipstick.
4. If required, add the specified oil up to the upper level mark. Do not overfill.
5. Reinstall the oil filler cap/dipstick.
Check for oil leaks.

※ Let the engine and exhaust system cool before working in those areas.



9.3. Engine oil replacement

Engine oil quality is the chief factor affecting engine service life. Change the engine oil as specified in the maintenance schedule.

When running in very dusty conditions, oil changes should be performed more frequently than specified in the maintenance schedule.

Please dispose of used engine oil in a manner that is compatible with the environment. We suggest you take it in a sealed container to your local recycling center or service station for reclamation. Do not throw it in the trash or pour it on the ground or down a drain.

1. Remove the oil filler cap/dipstick (1) from the right crankcase cover.
2. Place a container under the left crankcase.
3. Remove the oil drain plug (2) to drain the oil.
4. Reinstall the drain plug and tighten the drain plug to specification.

Oil drain plug torque: 2.5 kgf-m

5. Fill the crankcase with the recommended grade oil and install the oil fill cap.

Oil capacity (after draining): 1.0 liter

6. Start the engine and let it idle for 2–3 minutes.
7. Stop the engine and check that the oil level is at the upper level mark on the oil filler cap/dipstick with the scooter upright on firm, level ground. Make sure there are no oil leaks.

Used engine oil may cause skin cancer if repeatedly left in contact with the skin for prolonged periods. Although this is unlikely unless you handle used oil on a daily basis, it is still advisable to thoroughly wash your hands with soap and water as soon as possible after handling used oil.

Change the engine oil with the engine at normal operating temperature and the scooter on its center stand to assure complete and rapid draining.

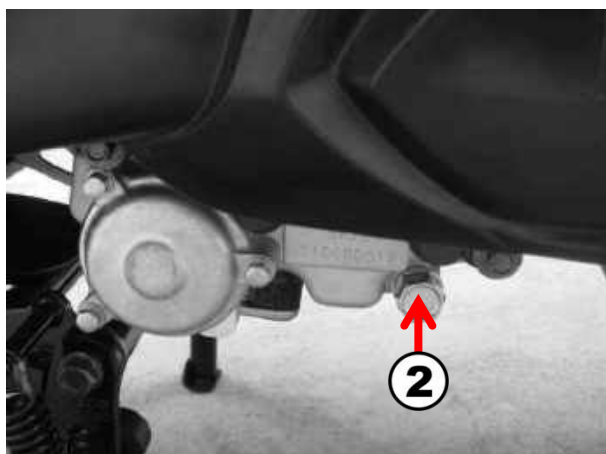
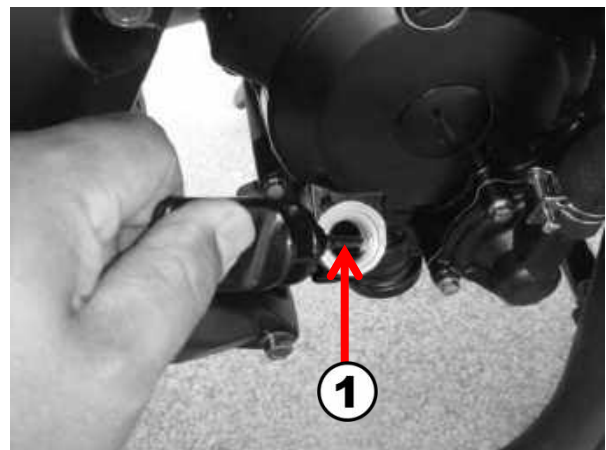

※ Let the engine and exhaust system cool before working in those areas.

9.4. Oil strainer screen clean

Change the engine oil with the engine at normal operating temperature and the scooter on its center stand to assure complete and rapid draining.

※ **Let the engine and exhaust system cool before working in those areas.**

1. Remove the oil filler cap/dipstick (1) from the right crankcase cover.
2. Place a drain pan under the crankcase and remove the oil strainer screen cap (2).
3. The spring (3) and oil strainer screen (4) will come out when the drain plug is removed.
4. Let the engine oil drain out.
5. Clean the oil strainer screen.
6. Check that the oil strainer screen, sealing rubber and drain plug O-ring are in good condition.
7. Install the oil strainer screen, spring and oil strainer screen cap.

Oil strainer screen cap torque: 1.5 kgf-m

8. Fill the crankcase with the recommended grade oil and install the oil filler cap.

Oil capacity (after draining): 1.0 liter

9. Start the engine and let it idle for 2–3 minutes.
10. Stop the engine and check that the oil level is at the upper level mark on the oil filler cap/dipstick with the scooter upright on firm, level ground. Make sure there are no oil leaks.

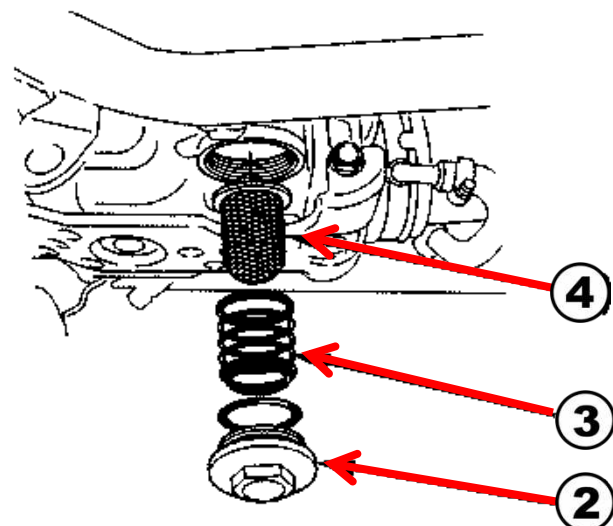
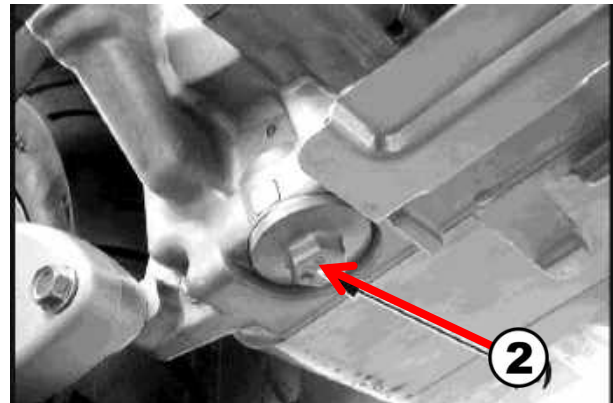
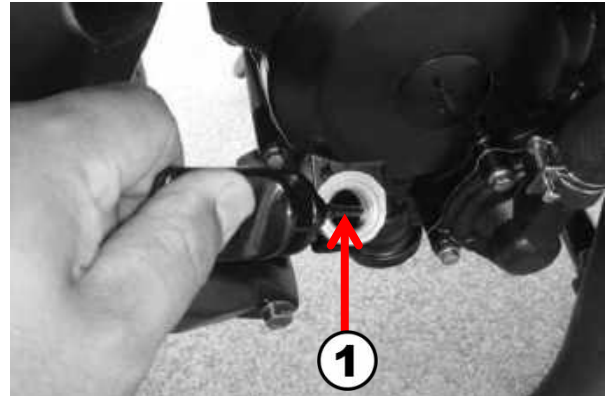

9.5. Oil filter replacement

Change the engine oil with the engine at normal operating temperature and the scooter on its center stand to assure complete and rapid draining.

※ **Let the engine and exhaust system cool before working in those areas.**

1. Remove the oil filler cap/dipstick (1) from the right crankcase cover.
2. Place a drain pan under the crankcase. Remove three bolts and then remove the oil filter cap (2) and O-ring (3). The spring (4) will come out when the filter cap is removed. Let the engine oil drain out.

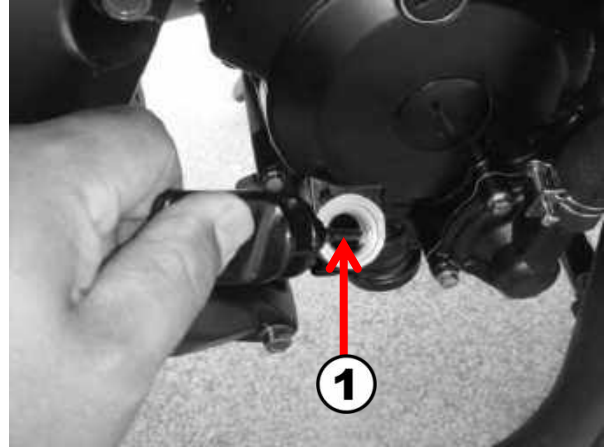

3. Remove and discard the oil filter (5).

※ **Do not remain the rubber seal on the oil filter in the oil filter housing.**

4. Check that the O-ring is in good condition.

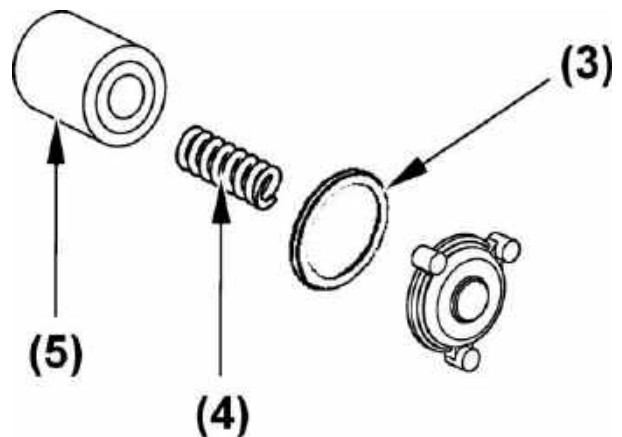
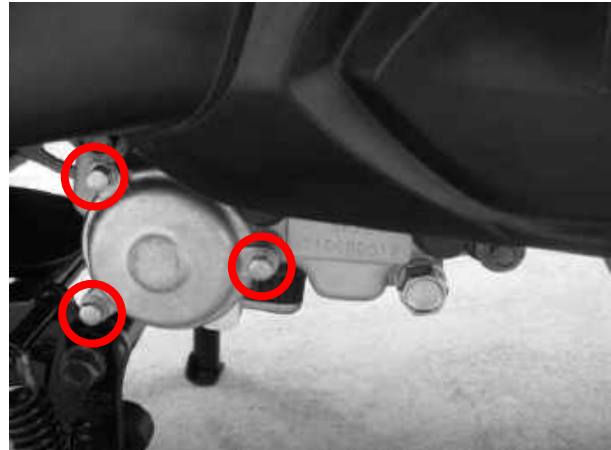

5. Install the new oil filter.

※ **Make sure the rubber seal on the oil filter facing the left crankcase.**

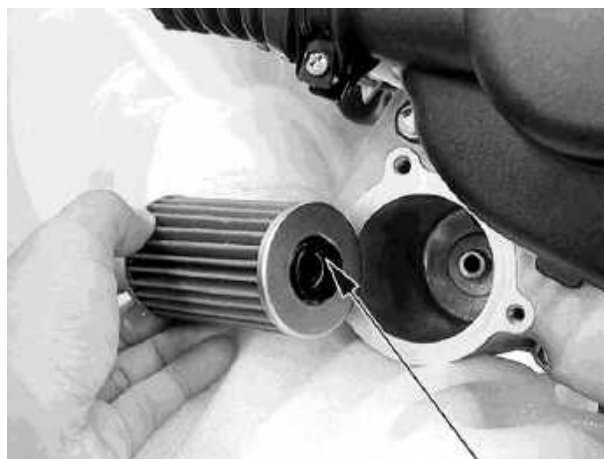

Rubber Seal

6. Install the spring, O-ring and cap.

Cap bolt torque: 1.2 kgf-m

7. Fill the crankcase with the recommended grade oil and install the oil filler cap.

Oil capacity (after draining): 1.0 liter

8. Start the engine and let it idle for 2–3 minutes.
9. Stop the engine and check that the oil level is at the upper level mark on the oil filler cap/dipstick with the scooter upright on firm, level ground. Make sure there are no oil leaks.



O-ring

Spring

10. Transmission Oil

10.1. Oil change

1. Place the scooter in its center stand.
2. Place a drain pan under the drain bolt (1).
3. Remove the transmission oil drain bolt.

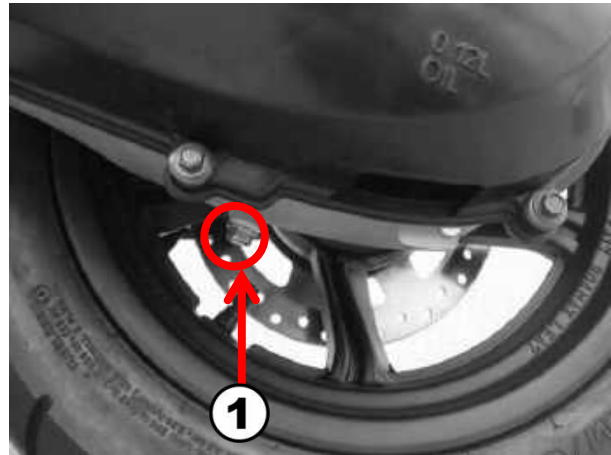

4. Remove the transmission oil filler bolt (2), slowly turn the rear wheel and drain the oil.

After draining the oil completely, install the oil drain bolt with a new sealing washer and tighten it.

Torque: 1.0kgf-m

5. Fill the transmission case with recommended oil.

Recommended transmission oil:

SAE 90

Oil capacity (at draining): 0.2 liter

6. Install the transmission oil filler bolt with a new sealing washer and tighten it.

Torque: 1.0kgf-m



11. Idle Speed

※ It is not necessary to adjust idle speed for DOWNTOWN125i. The throttle body is factory pre-set, do not loosen or tighten the painted bolts and screws of throttle body. Loosening or tightening them can cause throttle and idle and valve synchronization failure.

Idle Speed: 1700±100 rpm

Warm up the engine before this operation.
Start the engine and connect a tachometer.
Turn the throttle stop screw to obtain the specified idle speed.

When the engine misses or run erratic, adjust the pilot screw.

12. Drive Belt

Remove the left crankcase cover.

Inspect the drive belt for cracks or excessive wear.

Replace the drive belt with a new one if necessary and in accordance with the Maintenance Schedule.

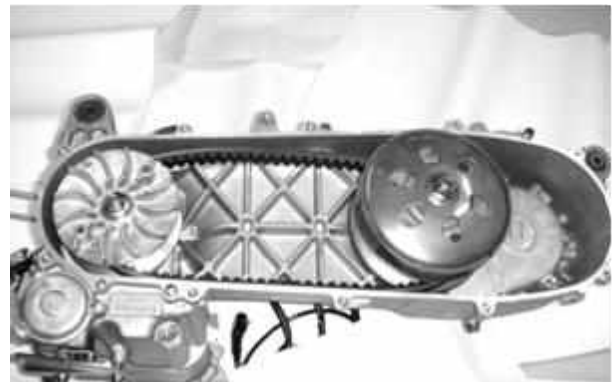

13. Clutch Shoe Wear

Start the engine and check the clutch operation by increasing the engine speed gradually.

If the scooter tends to creep, or the engine stalls, check the clutch shoes for wear and replace if necessary



14. Headlight Aim

Remove the front cover

Place the scooter on a level surface

Adjust the headlight beam adjuster.

A clockwise rotation moves the beam up and counterclockwise rotation moves the beam down.

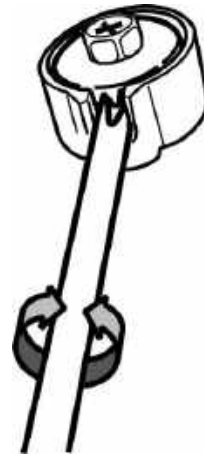

15. Coolant

15.1. Inspection

Check the coolant level through the inspection window at the right side of main switch with the scooter in an upright position on a level ground.

If the coolant level is below the LOWER level mark, remove the reserve tank cap to add coolant mixture until it reaches the F level mark.

Always add coolant to the reserve tank. Do not attempt to add coolant by removing the radiator cap.

If the reserve tank is empty, or if coolant loss is excessive, check for leaks and see your KYMCO dealer for repair.

15.2. Add coolant

Remove the screw (1).

Press the cover at (2) part to release the joint claw.

Remove the cover.

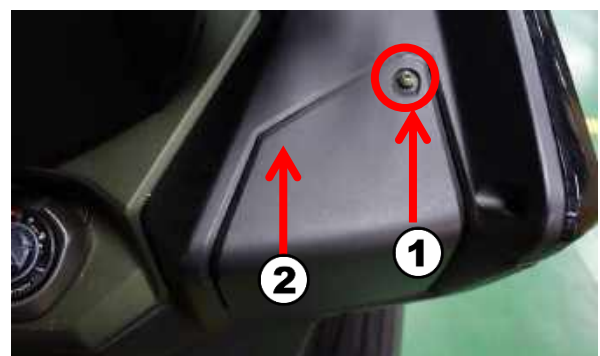
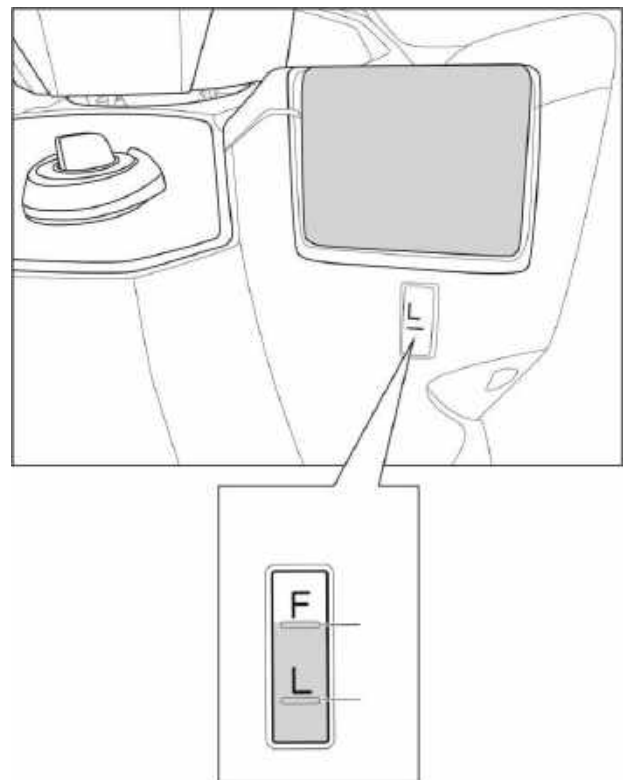

Remove the reserve tank cap to add coolant mixture until it reaches the F level mark.

- ※ **Removing the cap while the engine is hot that can cause the coolant to spray out, seriously scalding you. Always let the engine and radiator cool down before removing the cap.**
- ※ **Using poor quality coolant may shorten the service life of radiator. Please be careful.**
- ※ **Use only low mineral drinking water or distilled water for mixing cooling liquid.**



15.3. Coolant recommendation

The owner must properly maintain the coolant to prevent freezing, overheating, and corrosion, use only high quality ethylene glycol antifreeze containing corrosion protection inhibitors specifically recommended for use in aluminum engines. (See antifreeze container label.)

Use only low-mineral drinking water or distilled water as a part of the antifreeze solution. Water that is high in mineral content or salt may be harmful to the aluminum engine.

Using coolant with silicate inhibitors may cause premature wear of water pump seals or blockage of radiator passages.

Using tap water may cause engine damage. The factory provides a 50:50 solution of antifreeze and distilled water in this scooter. This coolant solution is recommended for most operating temperatures and provides good corrosion protection.

A higher concentration of antifreeze decreases the cooling system performance and is recommended only when additional protection against freezing is needed. A concentration of less than 40:60 (40% antifreeze) will not provide proper corrosion protection. During freezing temperatures, check the cooling system frequently and add higher concentrations of antifreeze (up to a maximum of 60% antifreeze) if required.

16. Brake

16.1. Brake fluid

Brake fluid level

With the scooter in an upright position, check the front and rear fluid level. It should be above the lower level mark. If the level is at or below the lower level mark "L", check the brake pads for wear.

Worn pads should be replaced. If the pads are not worn, have your brake system inspected for leaks.

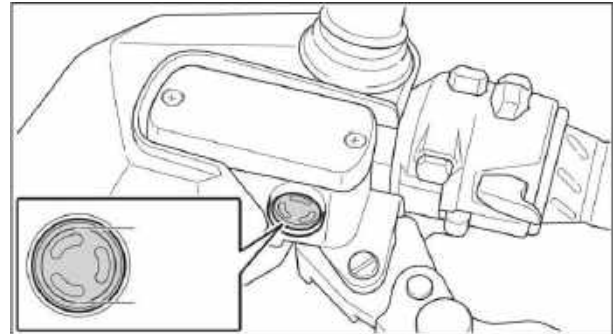

The recommended brake fluid is **DOT 4** brake fluid from a sealed container, or an equivalent.

Other checks:

Make sure there are no fluid leaks. Check for deterioration or cracks in the hoses and fittings.

※ **Warning: Brake fluid is very caustic and can damage paint, chrome and plastic. Wipe up any spills immediately.**

16.2. Brake pad wear

Brake pad wear depends upon the severity of usage, the type of riding, and road conditions. (Generally, the pads will wear faster on wet and dirty roads.) Inspect the pads at each regular maintenance interval.

Front brake

Check the cutout in each pad.

If either pad is worn to the cutout, replace both pads as a set. See your KYMCO dealer for this service.



Rear brake

Check the cutout in each pad.

If either pad is worn to the cutout, replace both pads as a set. See your KYMCO dealer for this service.



16.3. Brake levers

1. Adjust brake lever clearance using adjustment knob (totally 4 adjustment positions).
2. Push the brake lever forward and then turn the adjuster knob to align the number with the round punch mark on the lever
3. After adjustment, release the Brake Lever and check if the lever position is suitable for driver

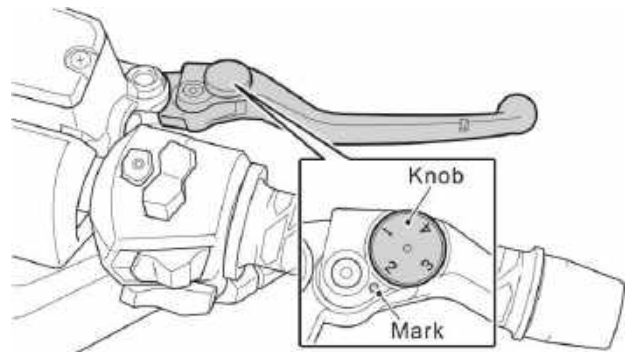

※ The distance from the grip to the released lever is at its closest at number 1 and the furthest away at number 4.

17. Nuts/Bolts/Fasteners

Check all important chassis nuts and bolts for looseness.

Tighten them to their specified torque values if any looseness is found

18. Wheels/Tires

18.1. Tire pressure

Insufficient air pressure in the tires not only hastens tire wear but also seriously affects the stability of the scooter. Under inflated tires make smooth cornering difficult and overinflated tires decrease the amount of tire in contact with the ground which can lead to skids and loss of control. Be sure that the tire pressure is within the specified limits at all times. Tire pressure should only be adjusted when the tires are cold.

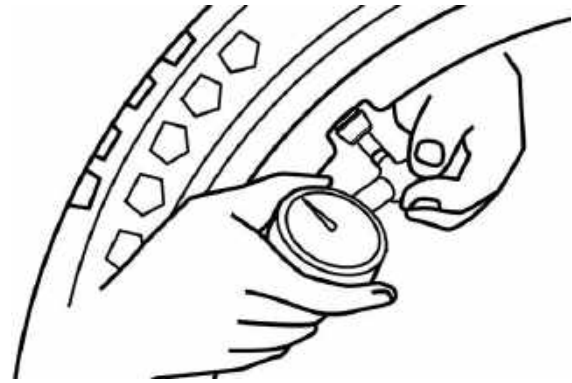

Service limit indication

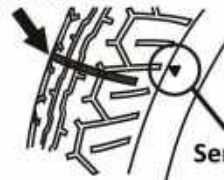

Service limit indication

Cold inflation tire pressure

	1 Rider (60 kg)	2 Riders (120 kg)
Front	2.0 kgf/cm ²	2.25 kgf/cm ²
Rear	2.0 kgf/cm ²	2.25 kgf/cm ²

19. Steering Handlebar

Raise the front wheel off the ground and check that the steering handlebar rotates freely.

If the handlebar moves unevenly, binds, or has vertical movement, adjust the steering head bearing.

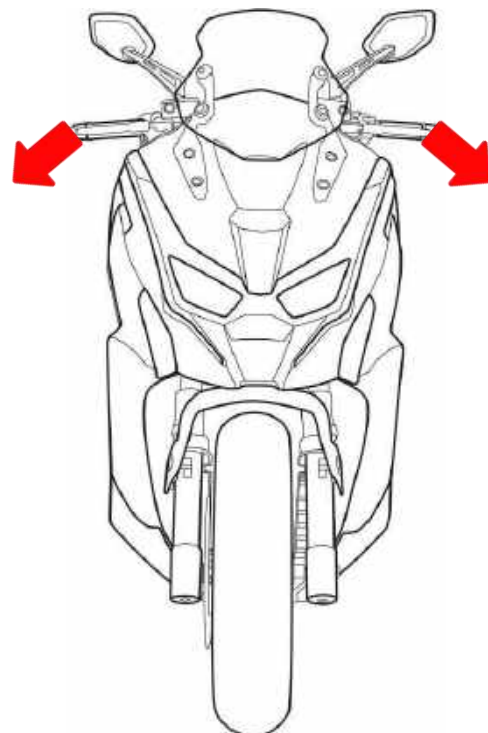

20. Suspension

Check the action of the front/rear shock absorbers by compressing them several times.

Check the entire shock absorber assembly for oil leaks, looseness or damage.

Jack the rear wheel off the ground and move the rear wheel sideways with force to see if the engine hanger bushings are worn.

Replace the engine hanger bushings if there is any looseness.

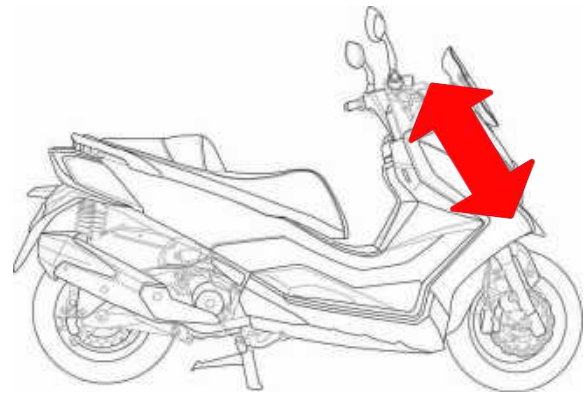

20.1. Rear suspension adjustment

Each shock absorber has 5 adjustment positions for different load or riding conditions.

Use a fitting wrench to turn the adjuster's boss.

Position 1 is for light loads and smooth road conditions.

Position 3 to 5 increase spring preload for a more stiff rear suspension and can be used under heavy loading.

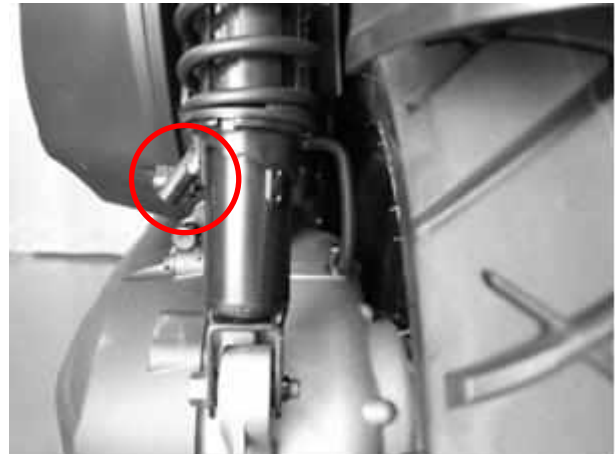

NOTE: Always adjust the shock absorber pre-load position in sequence (1-2-3-4-5 or 5-4-3-2-1). Attempting to adjust directly from 1 to 5 or 5 to 1 may damage the shock absorber.

Standard spring preload position: 3

21. Side Stand

Perform the following maintenance in accordance with the maintenance schedule.

21.1. Functional check:

Check the spring for damage or loss of tension and the side stand assembly for freedom of movement.

Check the side stand ignition cut-off system:

1. Place the scooter on its center stand.
2. Put the side stand up and start the engine.
3. Lower the side stand. The engine should stop as you put the side stand down.

If the side stand system does not operate as described, see your KYMCO dealer for service.



Side Stand Up



Side Stand Down

Lubrication System

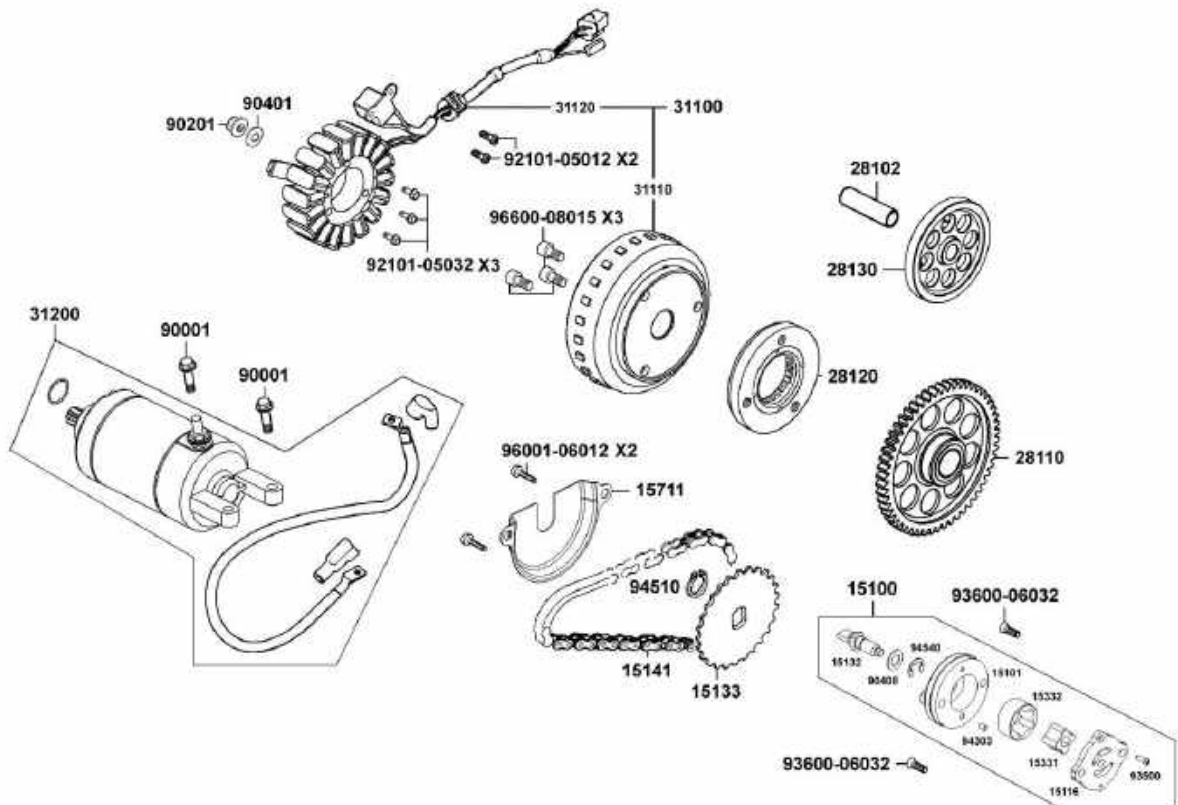
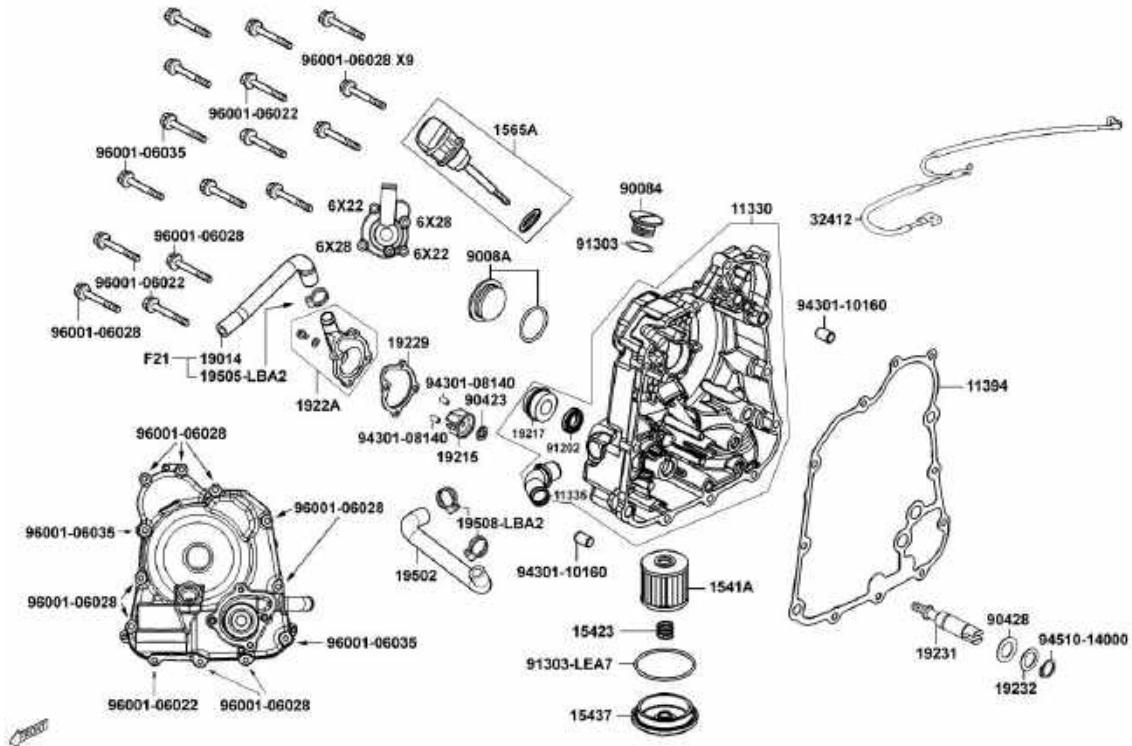

1.	Lubrication Diagram	3
2.	SERVICE INFORMATION.....	4
2.1.	GENERAL INSTRUCTIONS	4
2.2.	SPECIFICATIONS.....	4
2.3.	TROUBLESHOOTING	5
3.	Engine oil.....	6
4.	Oil Pump.....	6
4.1.	Removal.....	6
4.2.	Disassembly.....	7
4.3.	Inspection.....	7
4.4.	Assembly	8
4.5.	Installation.....	9

1. Lubrication Diagram

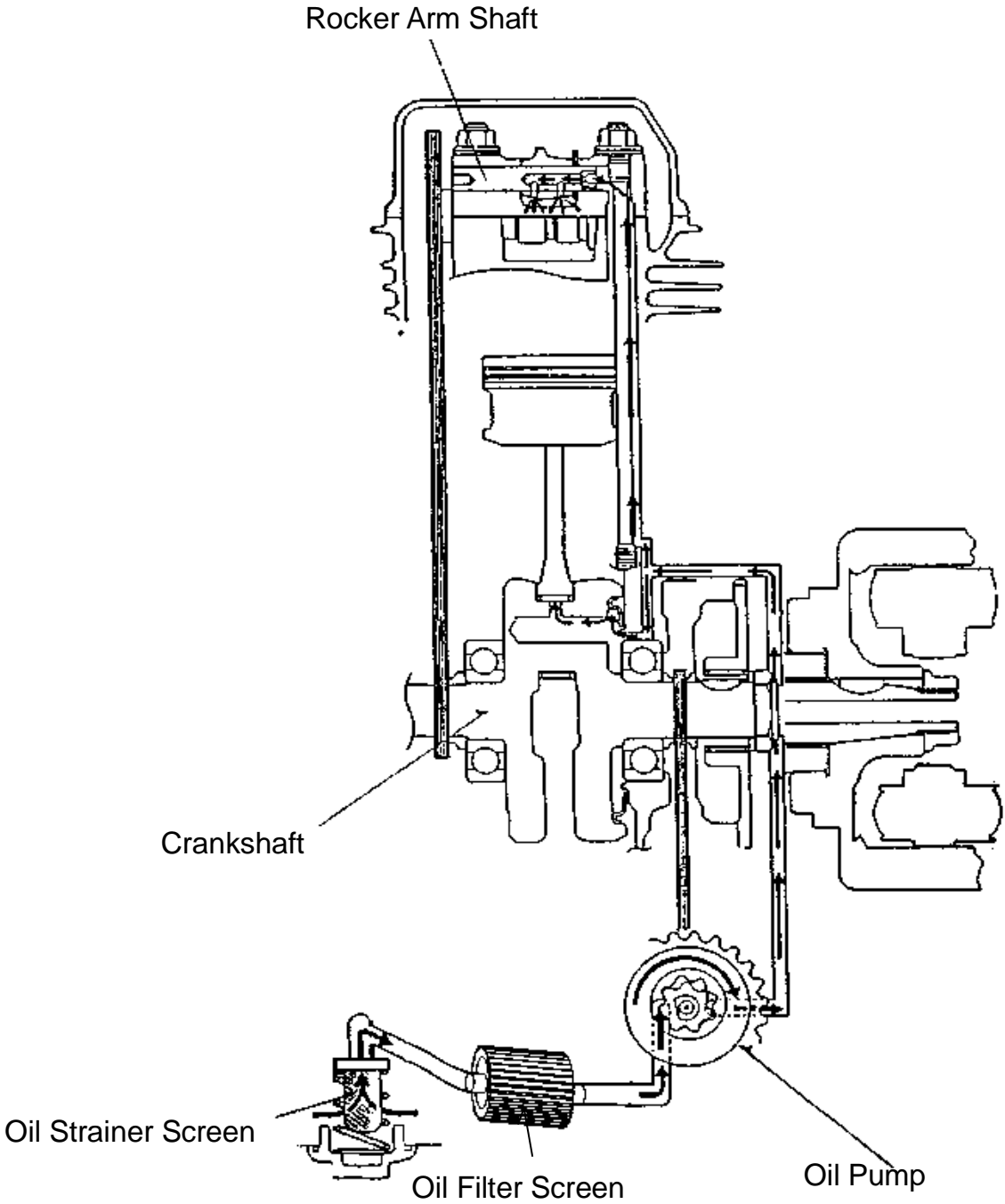

2. SERVICE INFORMATION

2.1. GENERAL INSTRUCTIONS

- The maintenance of lubrication system can be performed with the engine installed in the frame.
- Drain the coolant before starting any operations.
- Use care when removing and installing the oil pump not to allow dust and foreign matters to enter the engine and oil line.
- Do not attempt to disassemble the oil pump. The oil pump must be replaced as a set when it reaches its service limit.
- After the oil pump is installed, check each part for oil leaks.

2.2. SPECIFICATIONS

ENGINE OIL

Engine Oil Capacity	At disassembly	1.2 liter	
	At change	1.0 liter	
Recommended Oil		15W40	API: SJ or SM

2.3. TROUBLESHOOTING

Oil level too low

- Natural oil consumption
- Oil leaks
- Worn piston rings
- Worn valve guide
- Worn valve guide seal

Poor lubrication pressure

- Oil level too low
- Clogged oil filter or oil passage
- Faulty oil pump

Oil contamination

- Oil not changed often enough
- Faulty cylinder head gasket
- Loose cylinder head bolts

3. Engine oil

See the chapter 3 for more information.

4. Oil Pump

4.1. Removal

Drain the engine oil.

Remove the alternator cover, fly wheel, starter idle gear, shaft, pins and starter driven gear.

Remove the bolt and then oil pump cover.

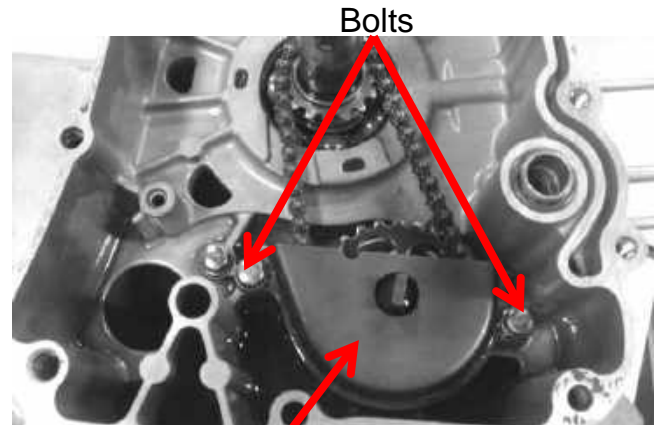

Oil Pump Cover

Pry the snap ring off and remove the oil pump driven gear, then remove the oil pump drive chain.

Inspect the oil pump drive chain and sprocket for signs of wear and damage. Replace the parts as needed.

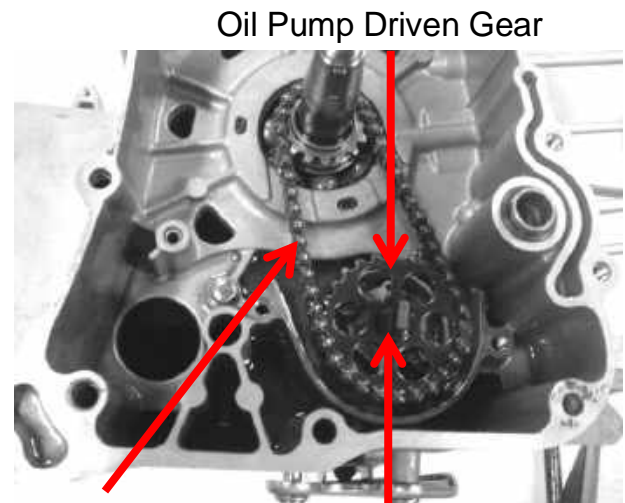

Drive Chain Oil Snap Ring

Remove the two oil pump bolts to remove the oil pump.

※ **When removing and installing the oil pump, use care not to allow dust or dirt to enter the engine.**

Turn the oil pump shaft by hand and make sure it turns smoothly. If the oil pump shaft will not rotate smoothly the oil pump should be replaced with a new unit.

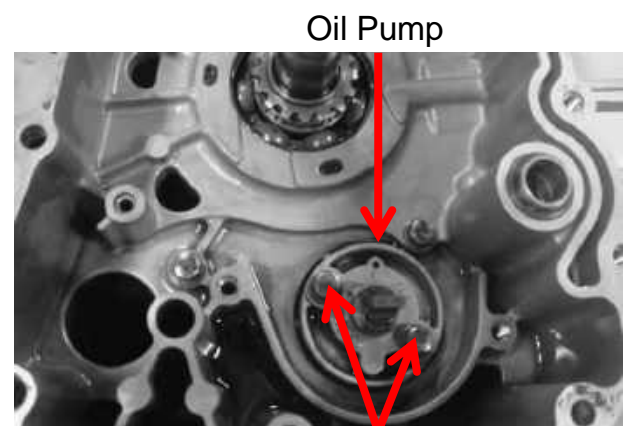

Bolts

4.2. Disassembly

Remove the screw and disassemble the oil pump as shown.

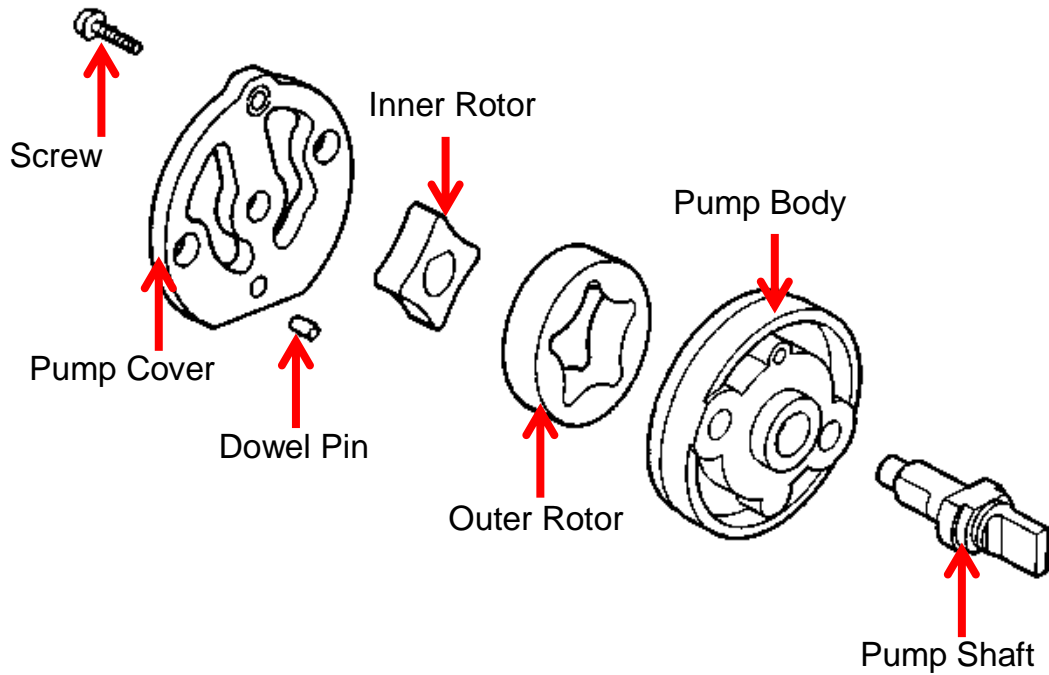

4.3. Inspection

Measure the pump body-to-outer rotor clearance.

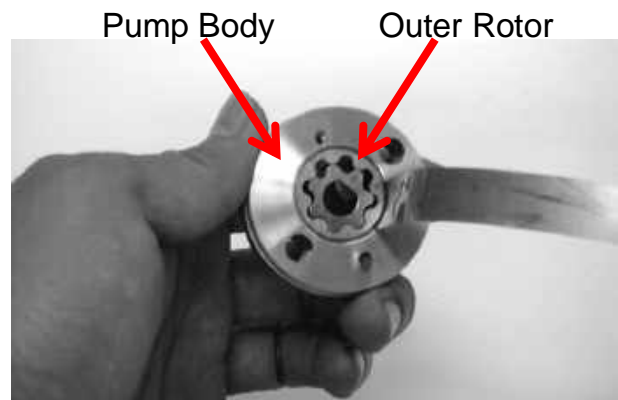

Measure the inner rotor-to-outer rotor clearance.

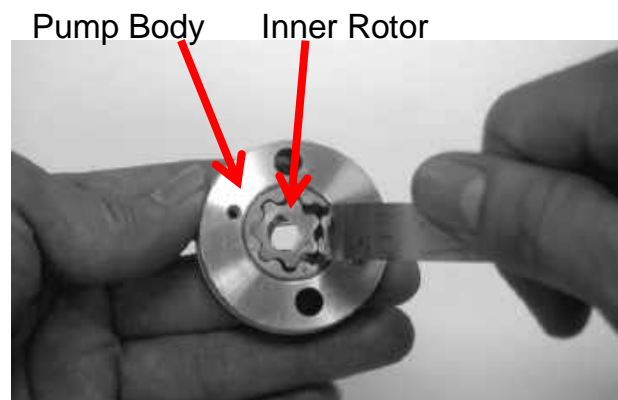

Measure the rotor end-to-pump body clearance.

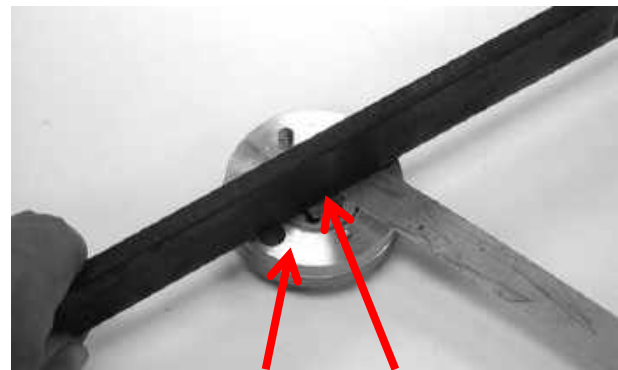

Pump Body

Rotor End

4.4. Assembly

Install the outer rotor, inner rotor and pump shaft into the pump body.

※ **Insert the pump shaft by aligning the flat on the shaft with the flat in the inner rotor. Install the dowel pin.**

There is one punch mark on the surface of the inner rotor and outer rotor.

The mark is upside.

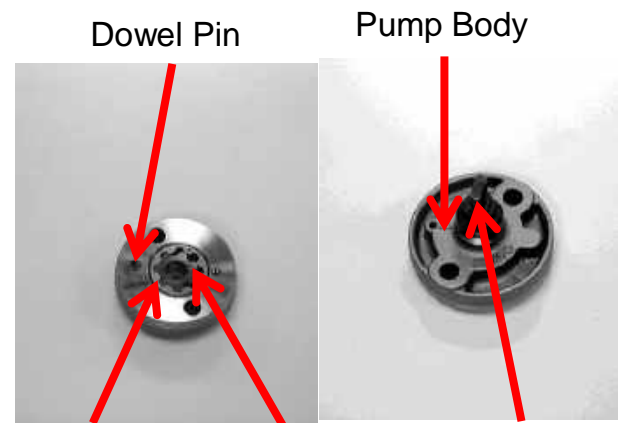

Outer Rotor

Inner Rotor

Pump Shaft

4.5. Installation

Install the oil pump and oil pump and tighten the two bolts.

※ **Make sure the pump shaft rotates freely and arrow mark which is on the oil pump is upside.**

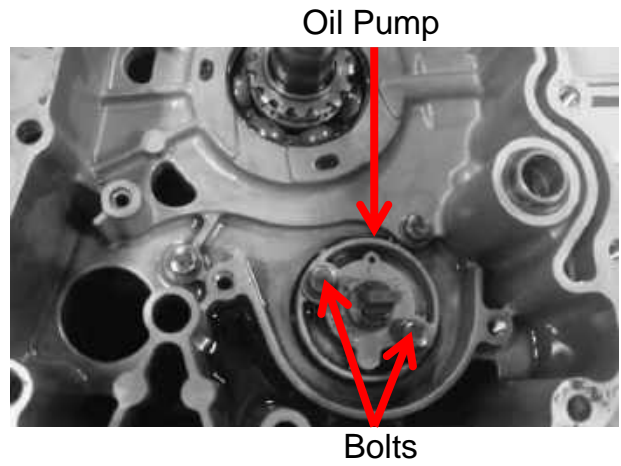

Install the pump drive chain and driven sprocket, then set the snap ring securely on the pump shaft.

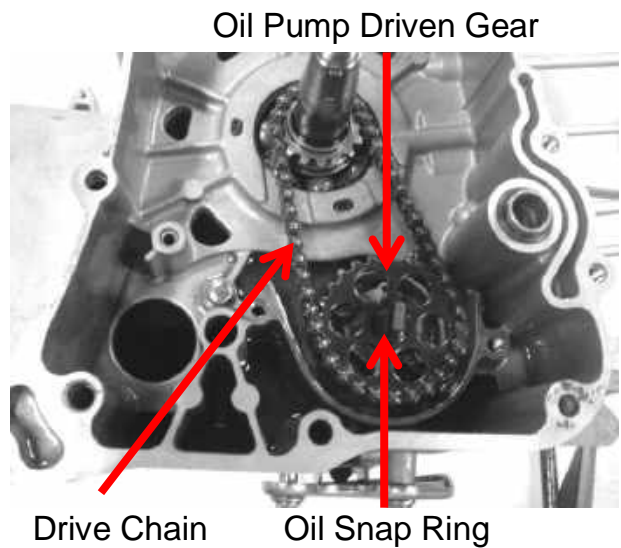

Install the oil pump cover properly. Tighten the bolts.

※ **Fit the tab of the pump cover into the slit in the pump.**

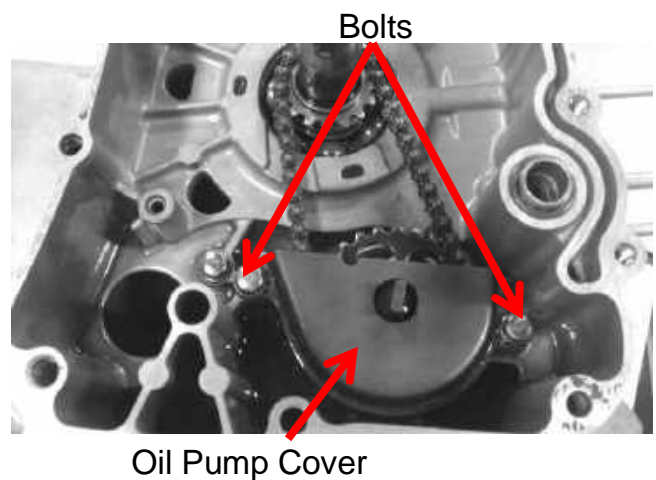

Engine

1. ENGINE REMOVAL/INSTALLATION	4
1.1. Removal.....	4
1.2. Installation.....	6

SERVICE INFORMATION

GENERAL INSTRUCTIONS

- A floor jack or other adjustable support is required to support and maneuver the engine. Be careful not to damage the scooter body, cables and wires during engine removal.
- Use shop towels to protect the scooter body during engine removal.
- Drain the coolant before removing the engine.
- After the engine is installed, fill the cooling system with coolant and be sure to bleed air from the water jacket. Start the engine to check for coolant leaks.
- Before removing the engine, the rear brake caliper must be removed first. Be careful not to bend or twist the brake fluid tube.
- Place the scooter on the center stand.
- Remove the following external components:
 - Seat
 - Center Cover
 - Front Cover
 - Front Lower Cover
 - Foot Skirt
 - Rear Carrier
 - Body Cover
 - Under Cover
- Disconnect the cables from the battery terminals. See the Battery topic for more information.
- Remove the spark plug cap. See the Spark Plug topic for more information.
- Drain the coolant. See the Coolant topic for more information.
- Drain the engine oil. See the Engine Oil topic for more information.
- Remove the airbox. See the Airbox topic for more information.
- Remove the rear brake caliper. See the Rear Brake Caliper topic for more information.
- Remove the throttle body. See the Throttle Body Removal and Installation topic for more information.
- Remove the exhaust system. See the Exhaust System topic for more information.

SPECIFICATIONS

ENGINE OIL CAPACITY	at disassembly	1.2 L
	at change	1.0 L
COOLANT CAPACITY	Radiator capacity + hoses	0.87 L
	Reserve tank capacity	0.49 L
TORQUE VALUES	Engine hanger bolts (Engine side)	5.0 kgf-m
	Engine hanger bolts (Frame side)	6.5 kgf-m
	Engine rear suspension mounting bolts	3.5 kgf-m
	Rear axle nut	12.0 kgf-m
	Rear shock absorber bolts	4.0 kgf-m
	Rear brake caliper mounting bolts	3.2 kgf-m

1. ENGINE REMOVAL/INSTALLATION

1.1. Removal

Remove the air cleaner.

Remove a bolt from fuel hose holder.

Disconnect the following connectors:

- Idle air bypass valve
- TPS
- WTS
- MAP
- Intake air pressure sensor
- O2 sensor
- Rectifier/ Regulator
- Fuel injector
- Thermostat

Remove the throttle cable.

Disconnect the fuel hose from fuel injector.

Remove the rubber cap on the starter motor lead.

Remove the starter motor lead nut. Free the cable lead from the starter motor. Thread the nut back on to keep track of it.

Disconnect the ground wire.

Loosen the water pump hose clamp with a #2 Phillips screwdriver. Slide up the clamp and free the coolant hose from the water pump. Allow any remaining coolant to drain into a suitable container.

Squeeze the air bleed hose clamp with needle nose pliers and slide back the clamp. Free the air bleed hose from the thermostat.

WTS connector



Fuel hose holder



Fuel injector



Ground wire



Air bleed hose



Coolant hose

5. ENGINE

Loosen the rear axle nut.

Support the scooter securely on its main stand.

Remove the bolts, and then remove the rear brake caliper.



Rear brake caliper bolts

Disconnect the alternator cord including the crank position sensor cord.



Remove the spark plug cap.



Remove the bolts.

Remove the shock absorbers.



Remove the engine mount nut.

Pull out the engine mount bolt.

Remove the engine from the frame.

※ **At removing the engine, be careful not to catch your hand or finger between the engine hanger and crankcase.**



1.2. Installation

Tighten the engine mounting bolts.

Torque: 5 kgf-m (Engine side)

6.5 kgf-m (Frame side)

Tighten the rear suspension bolts.

Torque: 3.5kgf-m

Tighten the right and left rear shock absorber lower mount bolts.

Torque: 4.0kgf-m

Tighten the rear axle nut.

Torque: 12.0kgf-m

Install the rear brake caliper and tighten the mount bolts.

Torque: 3.2 kgf-m

Installation is in the reverse order of removal.

※ **Install the cables and wires with the wire routine pics.**

After installation, inspect and adjust the following:

- Throttle grip free play
- Fill the cooling system with coolant and start the engine to bleed air from the system.

Cylinder Head/ Valve

1. SCHEMATIC DRAWING	2
2. SERVICE INFORMATION.....	3
2.1. General Instructions.....	3
2.2. Specifications	3
2.3. Torque Values	4
2.4. Special Tools.....	4
2.5. Troubleshooting	5
3. CYLINDER HEAD COVER.....	6
3.1. Removal	6
3.2. Installation	6
4. CAMSHAFT HOLDER.....	7
4.1. Removal	7
4.2. Installation	7
4.3. Disassembly	8
4.4. Inspection	8
4.5. Assembly	9
5. CAMSHAFT	10
5.1. Removal	10
5.2. Inspection	11
Camshaft.....	11
5.3. Installation	11
5.4. Disassembly	12
5.5. Inspection	13
Valve/ Valve Guide	13
Valve Spring.....	13
Cylinder Head	14
5.6. Assembly.....	14

1. SCHEMATIC DRAWING

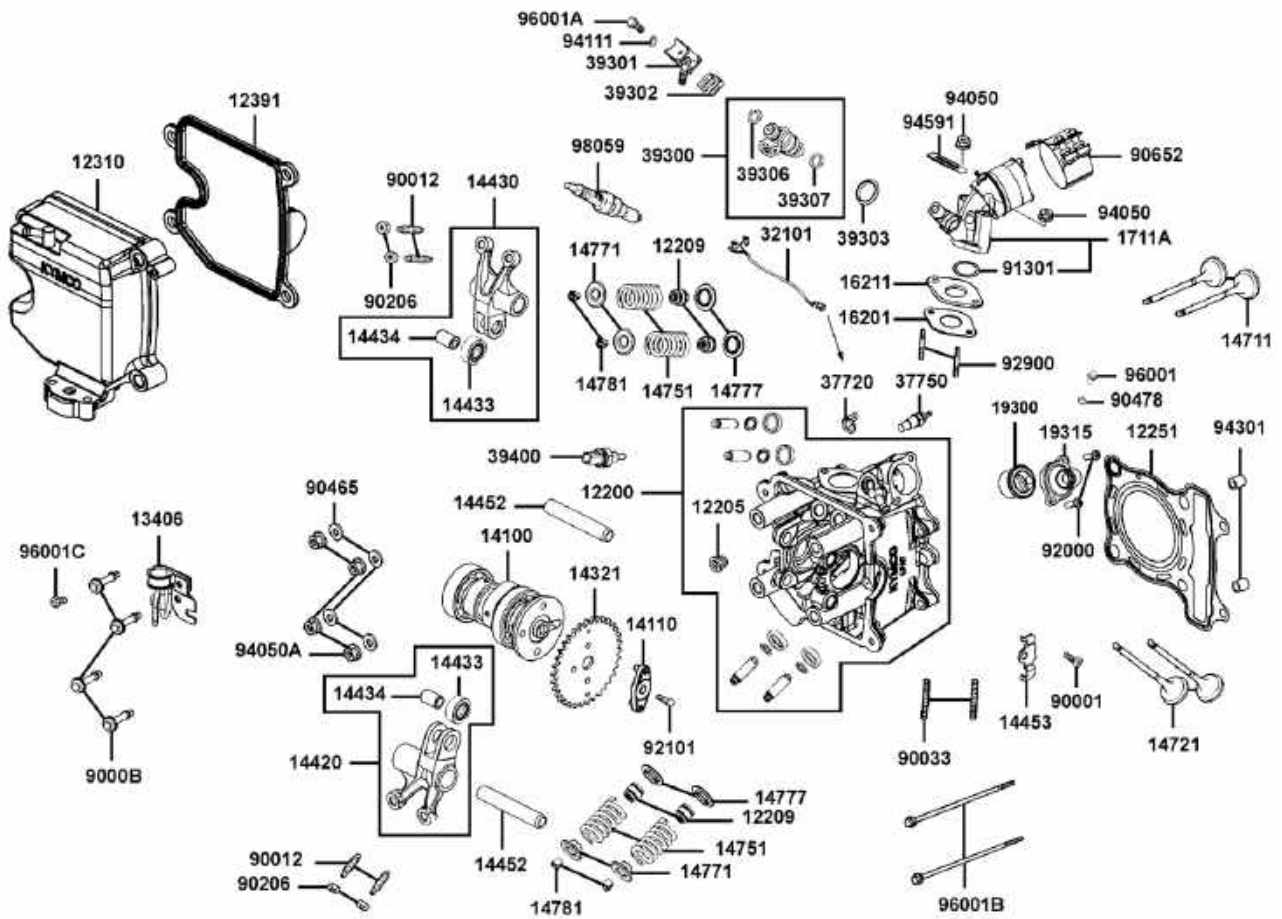

2. SERVICE INFORMATION

2.1. General Instructions

- The cylinder head can be serviced with the engine installed in the frame. Coolant in the radiator and water jacket must be drained first.
- When assembling, apply molybdenum disulfide grease or engine oil to the valve guide movable parts and valve arm sliding surfaces for initial lubrication.
- The valve rocker arms are lubricated by engine oil through the cylinder head engine oil passages. Clean and unclog the oil passages before assembling the cylinder head.
- After disassembly, clean the removed parts and dry them with compressed air before inspection.
- After removal, mark and arrange the removed parts in order. When assembling, install them in the reverse order of removal.

2.2. Specifications

Unit: mm

Item		Standard
Valve clearance (cold)	IN	0.1
	EX	0.1
Cylinder head compression pressure		15±2kgf/cm ²
Cylinder head warpage		—
Camshaft cam height	IN	25.965
	EX	25.810
Valve rocker arm I.D.	IN	10.0~10.015
	EX	10.0~10.015
Valve rocker arm shaft O.D.	IN	9.972~9.987
	EX	9.972~9.987
Valve stem O.D.	IN	4.975~4.970
	EX	4.975~4.970
Valve guide I.D.	IN	5.0~5.012
	EX	5.0~5.012
Valve stem-to-guide clearance	IN	0.010~0.037
	EX	0.030~0.057

2.3. Torque Values

Item	Value	Remark
Cylinder head cover bolt	0.8~0.9 kgf-m	
Tensioner mounting bolt	1.0~1.4 kgf-m	
Tensioner sealing bolt	0.5~0.5 kgf-m	
Cylinder head nut	1.8~2.2 kgf-m	
Cylinder head bolt	0.7~1.1 kgf-m	
Valve clearance fixing nut	0.7~1.1 kgf-m	Apply engine oil to threads

2.4. Special Tools

Valve spring compressor: A120E00051

Valve adjuster: A120E00012

2.5. Troubleshooting

The poor cylinder head operation can be diagnosed by a compression test or by tracing engine top-end noises.

Poor performance at idle speed

Compression too low

White smoke from exhaust muffler

Worn valve stem or valve guide

Damaged valve stem oil seal

Compression too low

Incorrect valve clearance adjustment

Burned or bent valves

Incorrect valve timing

Broken valve spring

Poor valve and seat contact

Leaking cylinder head gasket

Warped or cracked cylinder head

Poorly installed spark plug

Abnormal noise

Incorrect valve clearance adjustment

Sticking valve or broken valve spring

Damaged or worn camshaft

Worn cam chain tensioner

Worn camshaft and rocker arm

Compression too high

Excessive carbon build-up in combustion chamber or on piston head.

White smoke from exhaust muffler

Worn valve stem or valve guide

Damaged valve stem oil seal

Excessive smoke from exhaust muffler

Worn or damaged piston rings

Worn or damaged cylinder and piston

3. CYLINDER HEAD COVER

3.1. Removal

Remove the four bolts then remove the cylinder head cover.



3.2. Installation

Install a new cylinder head cover O-ring and install the cylinder head cover.

※ Be sure to install the O-ring into the groove properly

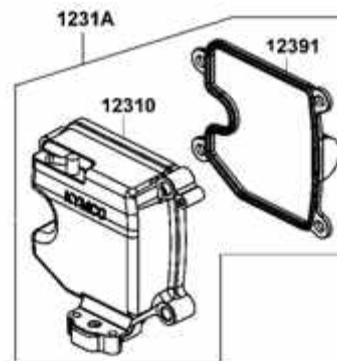

Install and tighten the cylinder head cover bolts to the specified torque in a crisscross pattern.

Torque: 0.8~0.9kgf-m



4. CAMSHAFT HOLDER

4.1. Removal

Turn the A.C. generator fly wheel so that the T mark on the flywheel aligns with the index mark on the crankcase. Hold the round hole on the camshaft gear facing up and location is the top dead center on the compression stroke. Remove the two bolts attaching cam chain tensioner and tensioner. Remove the four cap nuts and cylinder 2 bolts washers from camshaft holder and cylinder 2 bolts then remove the cam shaft Bolt.

Remove the camshaft gear and holder Bolt.



4.2. Installation

Install the camshaft gear, Holder bolt and holder washers and nuts. Tighten the four cylinder head nuts to the specified torque.

Torque:

1.8~2.2 kgf-m (Cylinder head nuts)

1.0~1.4 kgf-m (Cam shaft set plate bolt)

0.8~1.2 kgf-m (Cylinder head outer bolts)



- ※ Install the camshaft holder with the "EX" mark face exhaust valve side.
- ※ Apply engine oil to the threads of the cylinder head cap nuts.
- ※ Diagonally tighten the cylinder head cap nuts in 2~3 times.

4.3. Disassembly

Take out the valve rocker arm shafts
Remove the valve rocker arms.

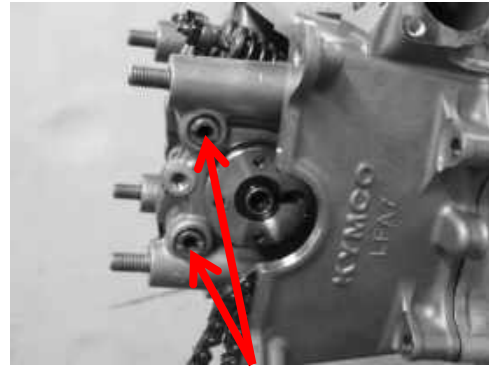

Rocker Arm Shaft

4.4. Inspection

Inspect the camshaft holder, valve rocker arms and rocker arm shafts for wear or damage.

※ If the valve rocker arm contact surface is worn, check each cam lobe for wear or damage.

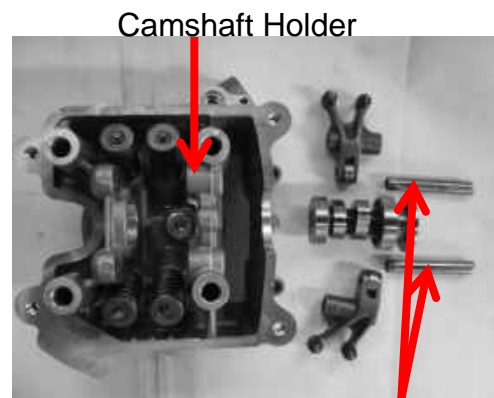

Camshaft Holder

Rocker Arm Shaft

Inspect the rocker arm bore, cam lobe contact surface and adjuster surface for wear/pitting/scratches/blue discoloration.

If any defects are found, replace the rocker arm shaft with a new one, and then inspect lubrication system.



Rocker Arm Bore

Adjust Surface

Contact Surface

Measure the I.D. of each valve rocker arm.

Service Limits:

IN: 10.1 mm

EX: 10.1 mm



Measure each rocker arm shaft O.D.

Service Limits:

IN: 9.9 mm

EX: 9.9 mm

Measure arm to shaft clearance.
Replace as a set if out of specification.

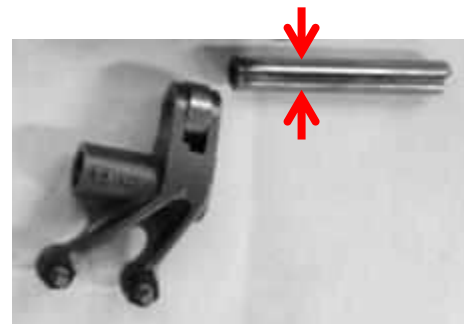

Service limits: 0.1 mm

4.5. Assembly

Apply engine oil to the rocker arms and rocker arm shafts.

Install the rocker arms and shafts into the camshaft holder.

- ※ **Install the exhaust valve rocker arm shaft on the “EX” side of the camshaft holder and the exhaust rocker arm shaft is shorter.**
- ※ **Clean the intake valve rocker arm shaft off any grease before installation.**
- ※ **Align the cutout on the exhaust valve rocker arm shaft with the bolt of the camshaft holder.**

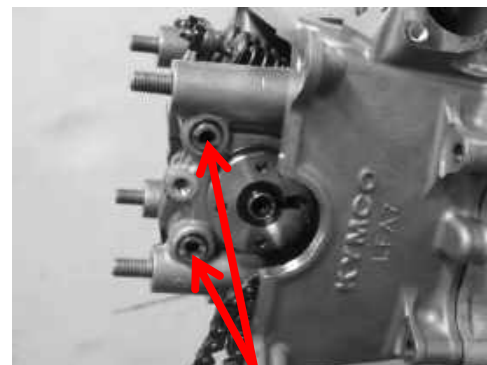

Rocker Arm Shaft

5. CAMSHAFT

5.1. Removal

Turn the A.C. generator flywheel so that the "T" mark on the flywheel aligns with the index mark on the crankcase. Hold the round hole on the camshaft gear facing up and the location is the top dead center on the compression stroke.



Remove the tensioner sealing bolt and spring.

Remove the two bolts from cam chain tensioner and then remove the tensioner and gasket.

Remove the camshaft holder

Remove the camshaft gear and holder Bolt.

Remove the camshaft from the cam chain.



5.2. Inspection

Camshaft

Inspect camshaft lobes for pitting/scratches/blue discoloration.

Measure the cam lobe height.

Service Limits:

IN : 25.57 mm

EX: 25.41 mm



If any defects are found, replace the camshaft with a new one, and then inspect lubrication system.

Check each camshaft bearing for play or damage. Replace the camshaft assembly with a new one if the bearings are noisy or have excessive play.



5.3. Installation

Turn the A.C. generator flywheel so that the "T" mark on the flywheel aligns with the index mark on the crankcase.

Keep the round hole on the camshaft gear facing up and align the punch marks on the camshaft gear with the cylinder head surface (Position the intake and exhaust cam lobes down.)

and install the cam chain over the camshaft gear.

Install the rocker arms shafts bolt.

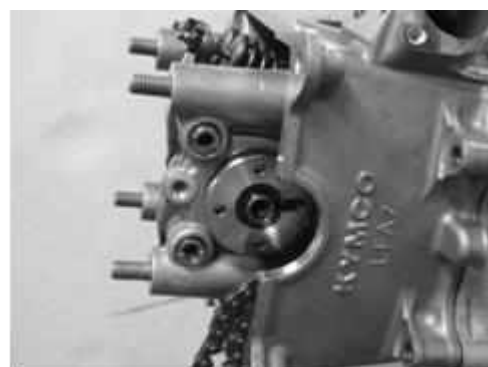
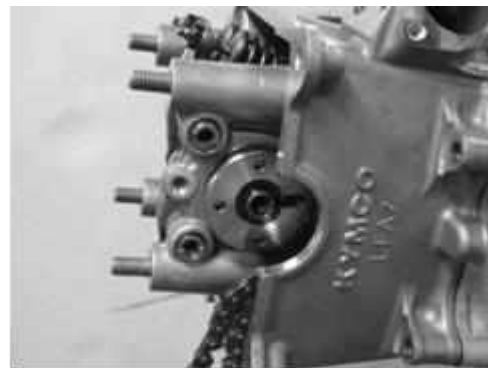

Install the camshaft gear

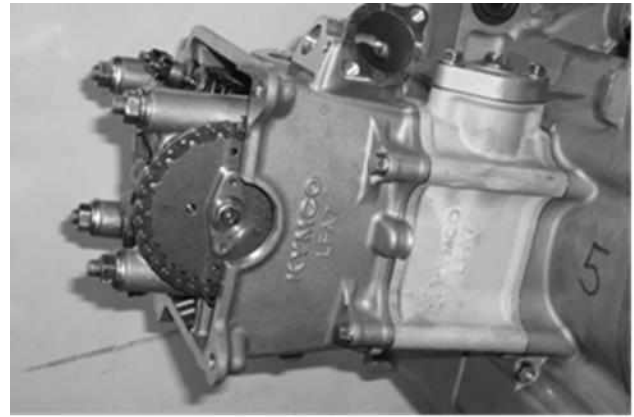

5.4. Disassembly

Remove the valve spring cotters, retainers, springs, spring seats, oil seals and valves using a valve spring compressor.

- ※ Be sure to compress the valve springs with a valve spring compressor.
- ※ Mark all disassembled parts to ensure correct reassembly.

Valve Spring Compression

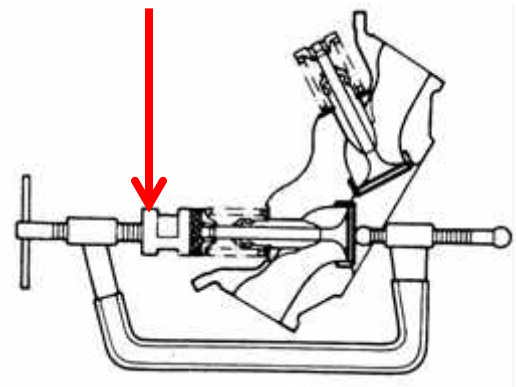

Special tool:

Valve Spring Compressor A120E00040

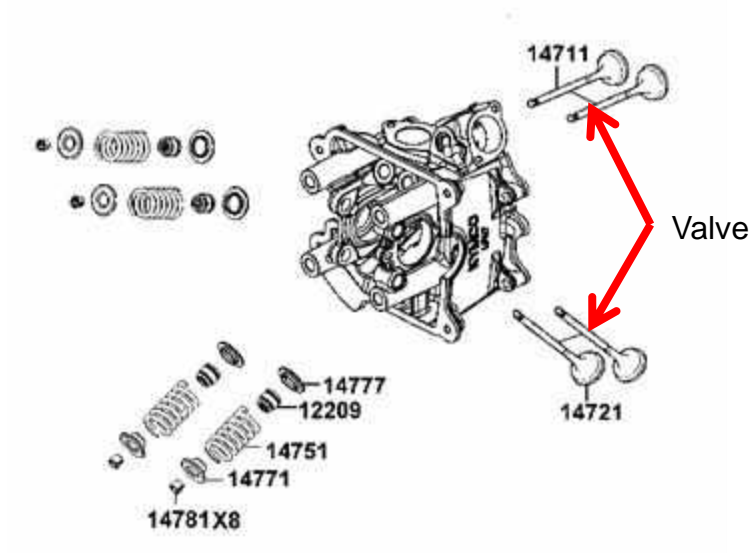

5.5. Inspection

Remove carbon deposits from the exhaust port and combustion chamber.

※ Be careful not to damage the cylinder head mating surface.



Valve/ Valve Guide

Inspect each valve for bending, burning, scratches or abnormal stem wear.

If any defects are found, replace the valve with a new one.

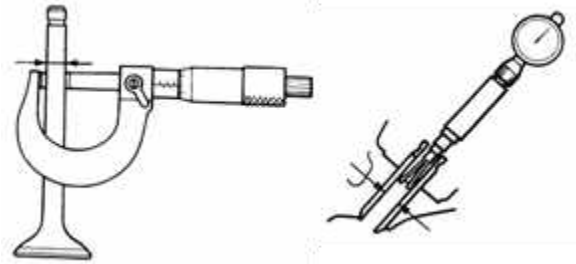

Check valve movement in the guide.
Measure each valve stem O.D.
Measure each valve guide I.D.
Subtract each valve stem O.D. from the corresponding guide I.D. to obtain the stem-to-guide clearance.

Service limits:

IN: 0.08 mm

EX: 0.1 mm

※ If the stem-to-guide clearance exceeds the service limits, replace the cylinder head is necessary.

Valve Spring

Measure the free length of the inner and outer valve springs.

Service Limit:

Inner: 29.3 mm

Outer: 32 mm

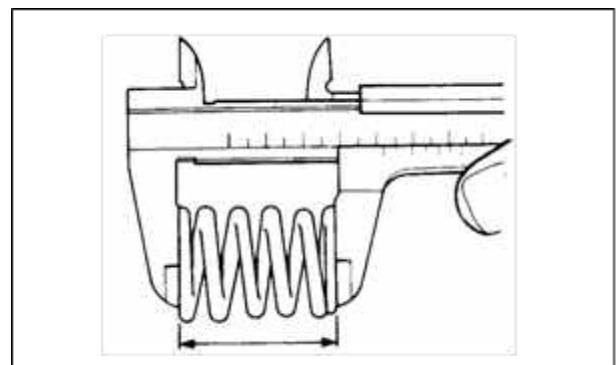

Cylinder Head

Check the spark plug hole and valve areas for cracks.

Check the cylinder head for warpage with a straight edge and feeler gauge.

Service Limit: 0.05 mm

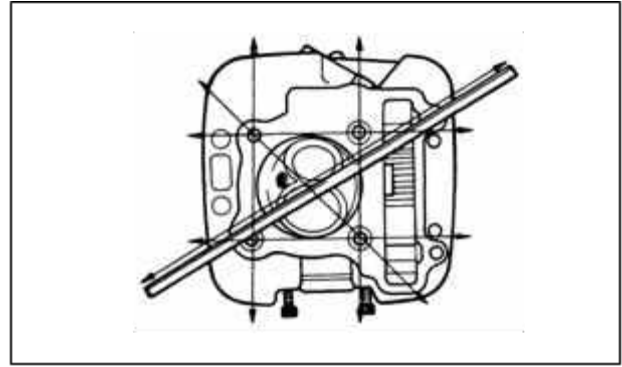

5.6.Assembly

Install the valve spring seats and oil seal.

※ **Be sure to install new oil seal.**

Lubricate each valve with engine oil and insert the valves into the valve guides.

Install the valve springs and retainers. Compress the valve springs using the valve spring compressor, then install the valve cotters.

※ **When assembling, a valve spring compressor must be used.**

※ **Install the cotters with the pointed ends facing down from the upper side of the cylinder head.**

Special tool:

Valve Spring Compressor A120E00040

Tap the valve stems gently with a plastic hammer for 2~3 times to firmly seat the cotters.

※ **Be careful not to damage the valves.**

Valve Spring Compression

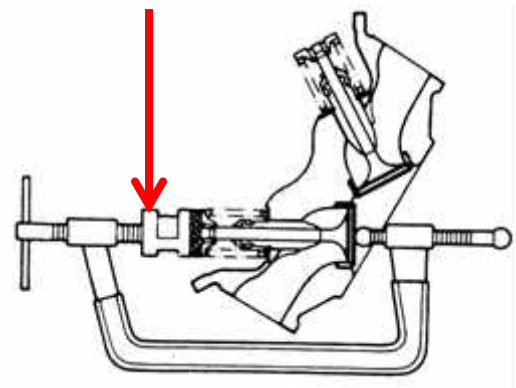

Rubber Hammer

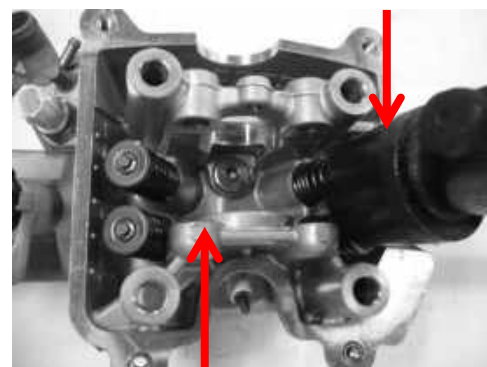

Cylinder Head

Cylinder/ Piston

1.	SCHEMATIC DRAWING	2
2.	SERVICE INFORMATION.....	3
2.1.	General Instructions.....	3
2.2.	Specifications	3
2.3.	Troubleshooting	4
3.	Cylinder and Piston	5
3.1.	Removal.....	5
3.2.	Inspection.....	6
	Piston ring	6
	Piston/Piston pin	7
	Cylinder	7
3.3.	Installation.....	9
	Piston ring	9
	Cylinder/Piston.....	9

1. SCHEMATIC DRAWING

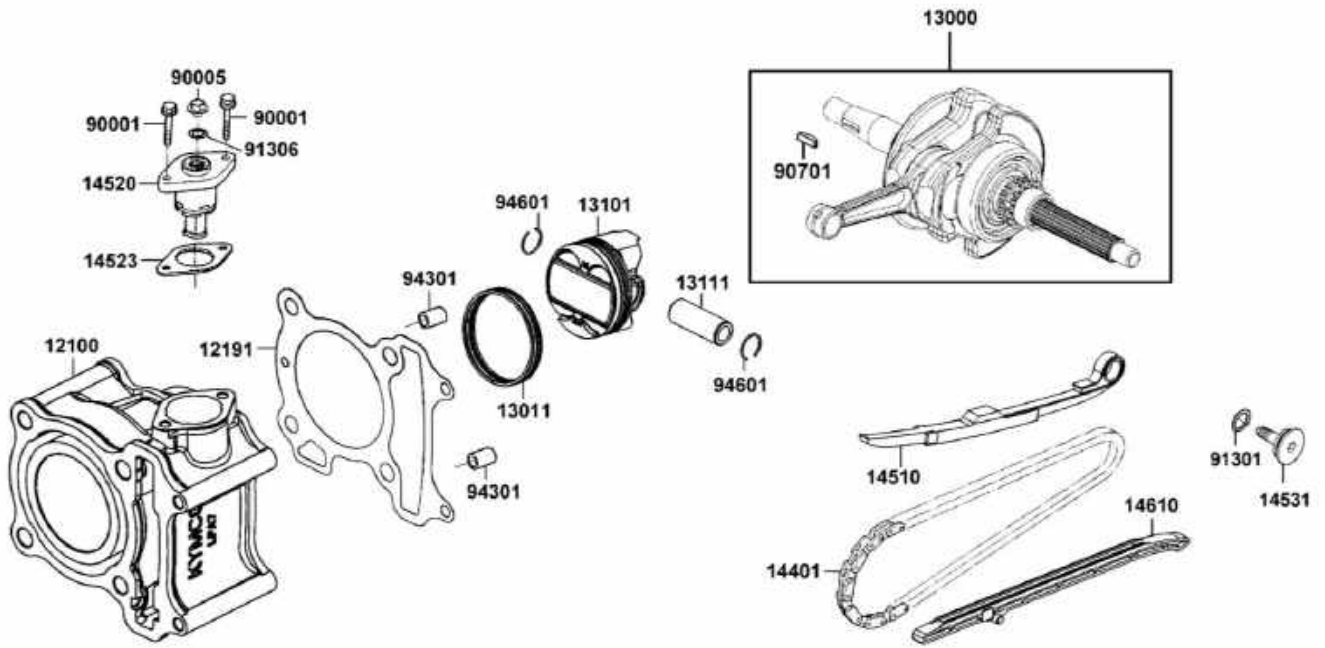

2. SERVICE INFORMATION

2.1. General Instructions

- The cylinder and piston can be serviced with the engine installed in the frame.
- When installing the cylinder, use a new cylinder gasket and make sure that the dowel pins are correctly installed.
- After disassembly, clean the removed parts and dry them with compressed air before inspection.

2.2. Specifications

Unit: mm

Item		Standard	
Cylinder	I.D.	52.4~52.41	
	Warpage	—	
	Cylindricity	—	
	True roundness	—	
Piston, piston ring	Ring-to-groove clearance	Top	0.015~0.055
		Second	0.015~0.055
	Ring end gap	Top	0.10~0.25
		Second	0.10~0.25
		Oil side rail	0.2~0.7
	Piston O.D.	52.37~52.39	
	Piston O.D. measuring position	9 mm from bottom of skirt	
	Piston-to-cylinder clearance	0.01~0.04	
Piston pin hole I.D.	15.002~15.008		
Piston pin O.D		14.994~15	
Piston-to-piston pin clearance		0.002~0.014	
Connecting rod small end I.D. bore		15.016~15.034	

2.3. Troubleshooting

When hard starting or poor performance at low speed occurs, check the crankcase breather for white smoke. If white smoke is found, it means that the piston rings are worn, stuck or broken.

Compression too low or uneven compression

- Worn or damaged cylinder and piston rings
- Worn, stuck or broken piston rings

Compression too high

- Excessive carbon build-up in combustion chamber or on piston head

Excessive smoke from exhaust muffler

- Worn or damaged piston rings
- Worn or damaged cylinder and piston

Abnormal noisy piston

- Worn cylinder, piston and piston rings
- Worn piston pin hole and piston pin
- Incorrectly installed piston

3. Cylinder and Piston

3.1. Removal

Remove the cylinder head

Remove the water hose from the cylinder.

Remove the cylinder.



Remove the cylinder gasket and dowel pins.
Clean any gasket material from the cylinder surface.



Remove the piston pin clip

※ Place a clean shop towel in the crankcase to keep the piston pin clip from falling into the crankcase.

Press the piston pin out of the piston and remove the piston.



Spread each piston ring and remove it by lifting up at a point opposite the gap

※ **Do not damage the piston ring by spreading the ends too far.**

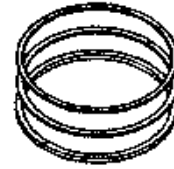

Clean carbon deposits from the piston ring grooves.

3.2. Inspection

Piston ring

Inspect the piston rings for movement by rotating the rings. The rings should be able to move in their grooves without catching.

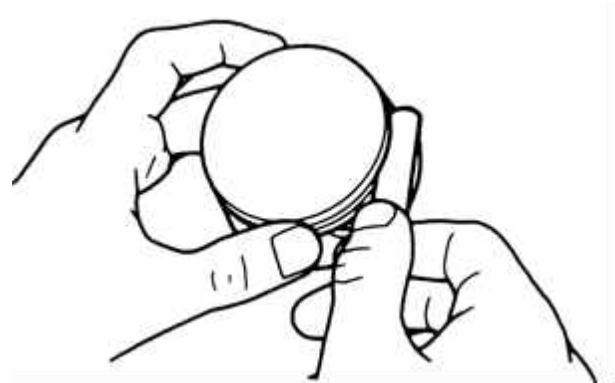

Push the ring until the outer surface of the piston ring is nearly flush with the piston and measure the ring-to-groove clearance.

Insert each piston ring into the bottom of the cylinder squarely.

※ **Use the piston head to push each piston ring into the cylinder.**

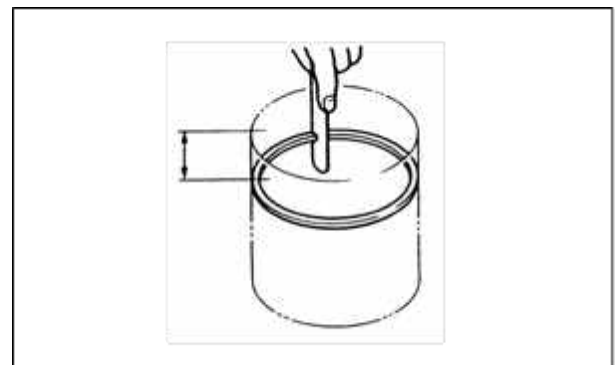

Measure the piston ring end gap.

Piston/Piston pin

Measure the piston O.D. at the point (A) from the bottom and 90° to the piston pin hole.

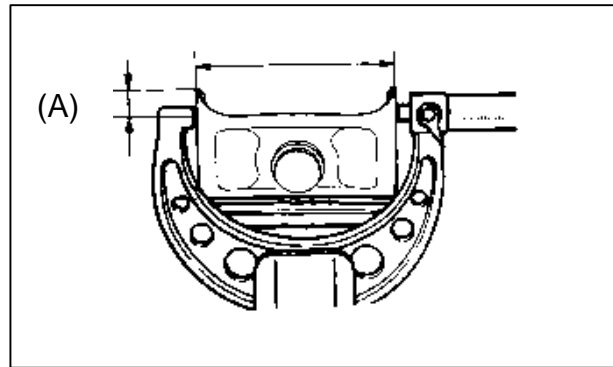

Calculate the cylinder-to-piston clearance.

Measure the piston pin hole. Take the maximum reading to determine the I.D.

Service Limit: 15.04 mm (0.6016 in)

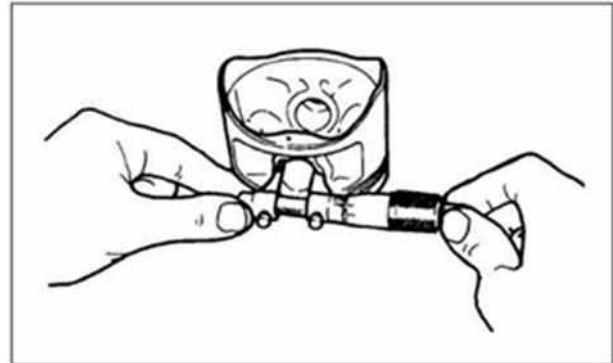

Measure the piston pin O.D. at piston and connecting rod sliding areas.

Service Limit: 14.96 mm (0.5984 in)

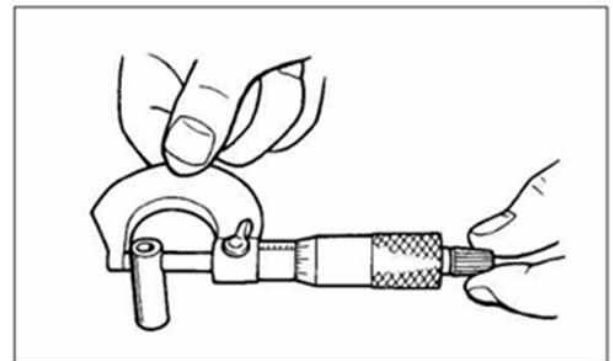

Measure the piston-to-piston pin clearance.

Service Limit: 0.02 mm (0.0008 in)

Cylinder

Check the cylinder for warpage with a straight edge and feeler gauge in the directions shown.



Check the cylinder wall for wear or damage. Measure and record the cylinder I.D. at three levels in an X and Y axis. Take the maximum reading to determine the cylinder wear.

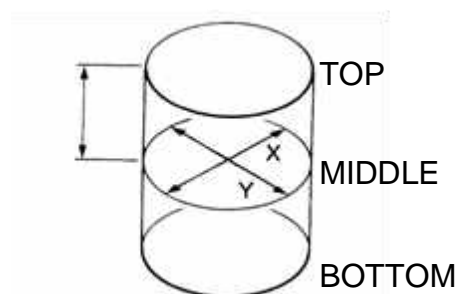

Calculate the piston-to-cylinder clearance.

Take a maximum reading to determine the clearance.

Calculate the taper and out-of-round at three levels in an X and Y axis. Take the maximum reading to determine them.

Measure the connecting rod small end I.D.

Calculate the connecting rod-to-piston pin clearance.



Inspect the exhaust side and intake side chain guides.

Wear/ Damage → Replace.

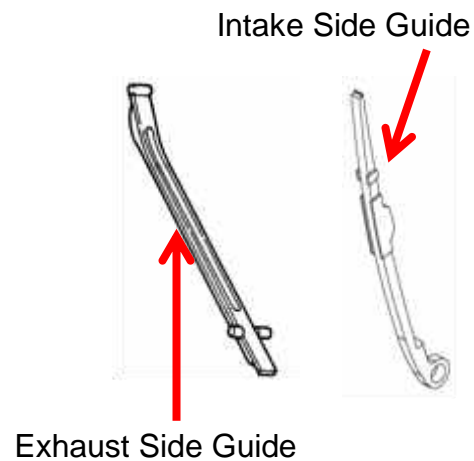

3.3. Installation

Piston ring

Carefully install the piston rings into the piston ring grooves with the markings facing up.

※ **Be careful not to damage the piston and rings.**

- ♦ Do not confuse the top and second rings.
- ♦ To install the oil ring, install the oil ring, and then install the side rails.

Stagger the piston ring end gaps 120° degrees apart from each other.

Stagger the side rail end gaps as shown.

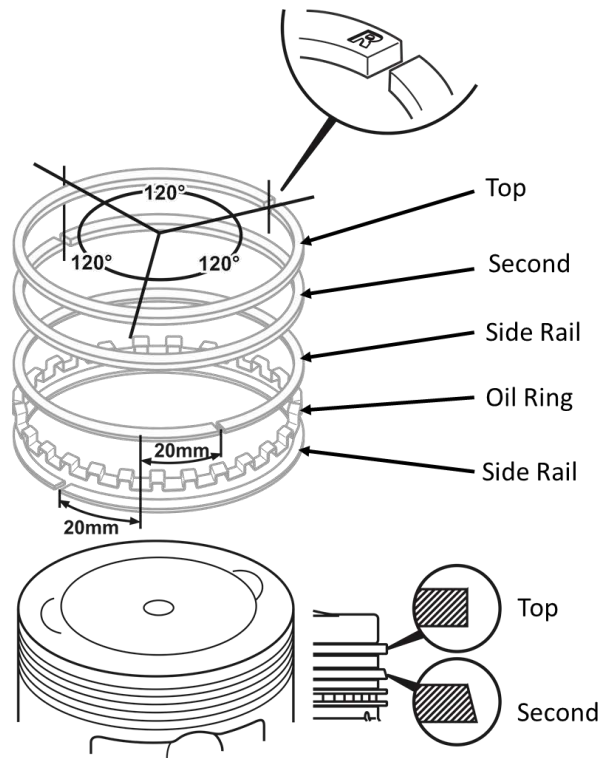

Cylinder/Piston

Clean any gasket material from the cylinder mating surfaces of the crankcase and oil passage.

- Apply engine oil to the piston pin.
- Apply engine oil to the connecting rod small end and piston pin hole.

Install the piston with the “IN” mark face intake side and piston pin.



7. CYLINDER/ PISTON

Place a clean shop towel over the crankcase prevent the clip from falling into the crankcase.

Install the new pin clip.

- ※ **Make sure that the piston pin clips are seated securely.**
- ※ **Do not align the piston pin clip end gap with the piston cut-out**



Install the dowel pins and gasket.



Apply engine oil to the cylinder wall, piston and piston ring outer surfaces.

Pass the cam chain through the cylinder and install the cylinder over the piston.

- ※ **Be careful not to damage the piston rings and cylinder walls.**

Install the cylinder head and camshaft holder has installed



Connect the water hose.

Drive & Driven Pulleys

1. SCHEMATIC DRAWING	2
2. SERVICE INFORMATION.....	3
2.1. General Instructions.....	3
2.2. Specifications	3
2.3. Torque Values	3
2.4. Special Tools.....	3
2.5. Troubleshooting	4
3. Left Crankcase Cover.....	5
3.1. Removal	5
3.2. Installation	5
4. Drive Pulley, Drive Belt and Driven Pulley	6
4.1. Removal	6
4.2. Installation	8
5. Drive Pulley	9
5.1. Disassembly	9
5.2. Inspection	10
Weight rollers	10
Movable drive face/Slide pieces/Drive pulley face	10
5.3. Assembly.....	11
6. Driven Pulley	12
6.1. Disassembly	12
6.2. Inspection	13
6.3. Assembly	14

1. SCHEMATIC DRAWING

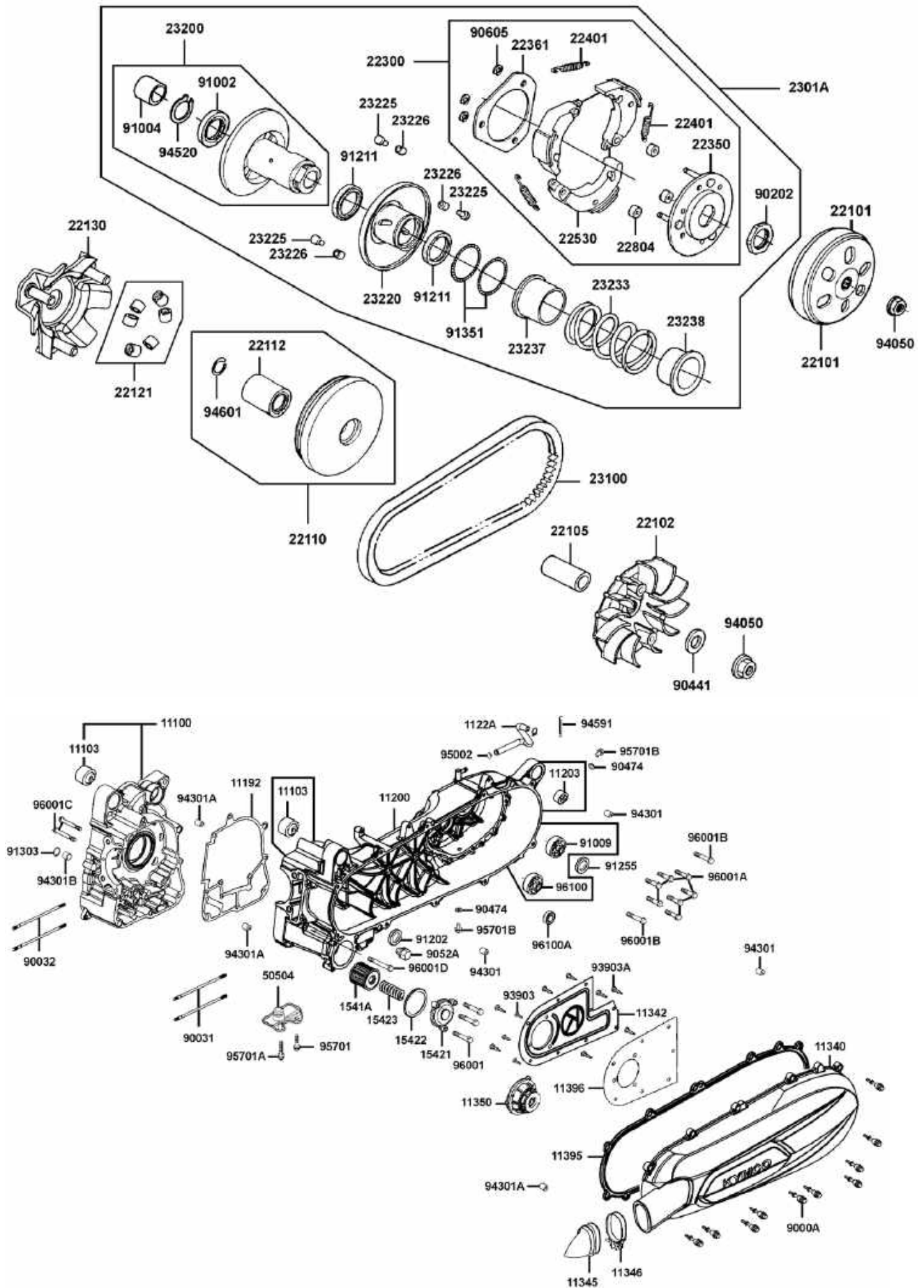

2. SERVICE INFORMATION

2.1. General Instructions

- The drive pulley, clutch and driven pulley can be serviced with the engine installed.
- Avoid getting grease and oil on the drive belt and pulley faces. Remove any oil or grease from them to minimize the slipping of drive belt and drive pulley.

2.2. Specifications

Unit: mm

Item	Standard
Movable drive face bushing I.D.	24.011~24.052
Drive face collar O.D.	23.960~23.974
Clutch outer I.D.	130~130.2
Driven face O.D.	33.965~33.985
Movable driven face I.D.	34~34.025
Weight roller O.D.	17.920~18.080

2.3. Torque Values

Left crankcase cover	1.2 kgf-m
Drive face nut	5.5~6.5 kgf-m
Clutch outer nut	5.0~6.0 kgf-m
Clutch plate comp	5.0~6.0 kgf-m

2.4. Special Tools

Bearing installer	A120E00014
Universal holder	A120E00017
Clutch spring compressor	A120E00053

2.5. Troubleshooting

Engine starts but motorcycle won't move

- Worn drive belt
- Broken ramp plate
- Worn or damaged clutch lining
- Broken driven face spring

Engine stalls or motorcycle creeps

- Broken clutch weight spring

Lack of power

- Worn drive belt
- Weak driven face spring
- Worn weight roller
- Faulty driven face

3. Left Crankcase Cover

3.1. Removal

Remove the 10 left crankcase cover bolts and then remove the left crankcase cover. Remove the gasket and dowel pins.



3.2. Installation

Install the dowel pins and gasket.

Install the left crankcase cover.

Install and tighten the 10 bolts diagonally to specified torque.

※ Do not pull out the kick starter spindle. Press in the kick starter spindle when installing the left crankcase cover.

4. Drive Pulley, Drive Belt and Driven Pulley

4.1. Removal

Remove the left crankcase cover (refer to the "LEFT CRANKCASE COVER" section in this chapter).

Use the special tool to hold the drive pulley, and then remove the nut and ratchet.

Special tool:

Universal holder A120E00017



Remove the drive pulley face and washer. Hold the clutch outer with the universal holder and remove the clutch outer nut.

Special tool:

Universal Holder A120E00017



Remove the clutch outer, driven pulley assembly and drive belt together.



Remove the movable drive face assembly.



Drive belt inspection

Check the drive belt for cracks, separation or abnormal or excessive wear.

Measure the drive belt width.

※ Use specified genuine parts for replacement.

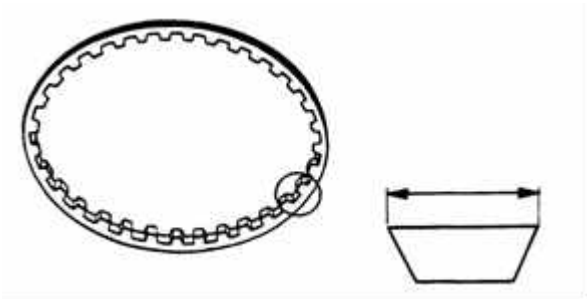

Clutch out inspection

Inspect the clutch outer for wear or damage.

Measure the clutch outer I.D.

Standard Value: 130~130.2mm



4.2. Installation

Apply lubricant to the drive face boss inner surface then install the movable drive face assembly.



Install the clutch outer onto the driven pulley assembly.

Compress the driven pulley assembly by hand then install the drive belt into the driven pulley assembly.



※ The drive belt should be installed so that the arrows on the drive belt periphery point in the normal turning direction if the drive belt has arrow mark.

※ The drive belt contact surface of the driven face should be thoroughly cleaned.

Install the driven pulley assembly/clutch outer and drive belt together.

Use the special tool to hold clutch outer, then tighten the nut to the specified torque.

Torque: 5.0~6.0kgf-m (50 ~60N-m)

Special tool:

Universal holder A120E00017



Install the drive pulley face and ratchet.
Use the special tool to hold drive pulley face,
and then tighten the nut to the specified
torque.

Torque:

5.5~6.5 kgf-m (55~65 N-m)

Special tool:

Universal holder A120E00017



5. Drive Pulley

5.1. Disassembly

Remove the drive face boss.



Remove the ramp plate



Remove the six weight rollers.



5.2. Inspection

Weight rollers

Check each roller for wear or damage.
Measure outside diameter.

Service limit: 19.8 mm (0.792 in)

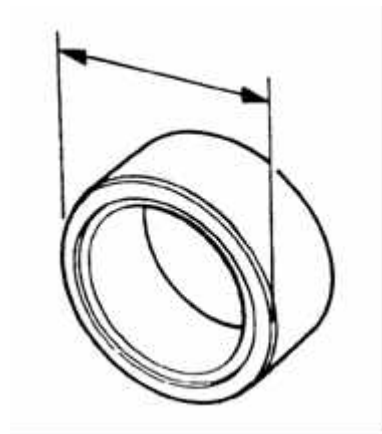

Movable drive face/Slide pieces/Drive pulley face

Check the movable drive face splines for wear, cracks or damage.

Check the ramp plate for cracks or damage.



Check the movable drive face and drive pulley face cracks or damage.

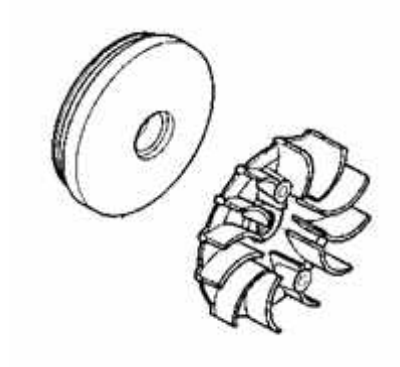

5.3. Assembly

Clean the movable drive face, drive pulley face, weight rollers, slide pieces, ramp plate and drive face boss.

※ Remove any excess grease.



Install the weight rollers.

※ The direction of all weight rollers is the same. The thin side is towards to clockwise.



Install the slide pieces and ramp plate.



Install the drive face boss.



6. Driven Pulley

6.1. Disassembly

Hold the clutch/driven pulley assembly with the clutch spring compressor.

※ Be sure to use a clutch spring compressor to avoid spring damage.

Special tool:

Clutch Spring Compressor A120E00034

Set the tool in a vise and remove the clutch drive plate nut.

Remove the clutch.

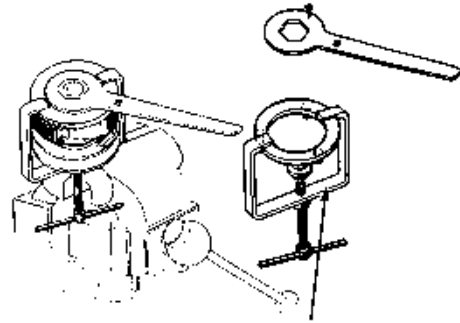

Remove the spring.

Remove the spring collar on the movable driven face.

Remove the three guide pins/rollers, and then remove the movable driven face.

Remove the needle bearing from driven face.

Remove the snap ring, then remove the bearing from driven face.

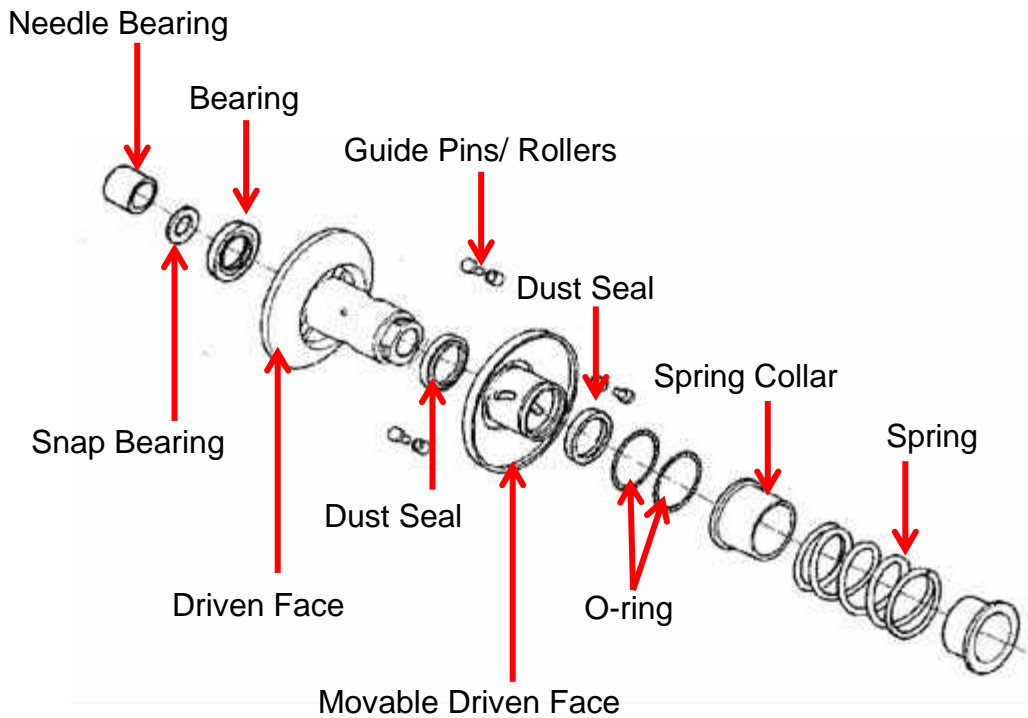

6.2. Inspection

Check the driven pulley for smooth operation. If any scratches or damage is found then replace as a set.

Check the torque cam grooves for wear or damage.

Check guide pins and rollers for wear or damage.

If any scratches or damage is found then replace as a set.

Check the spring for damage. Measure the spring free length.

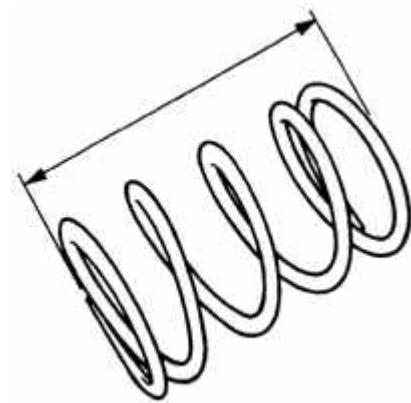

Check the clutch shoe for heat damage.

Measure the clutch shoe thickness.



6.3. Assembly

Clean any oil from the drive belt sliding surfaces on the driven face.

Filling 12 g of grease to driven face inner side.

Apply grease to lips of the new dust seals and install into the movable driven face.

Coat new O-rings with grease and install them into the movable driven face grooves.

Install the movable driven face onto the driven face.

Install the guide rollers and guide roller pins.

Filling 5 g of grease to each guide groove.

Install the guide pins/rollers.

Install spring collar.

Use the special tool to install spring and clutch, then install and tighten the nut to the specified torque.

Torque: 5.5 ~6.5m (55~65N-m)

Special tool:

Clutch Spring Compressor A120E00034

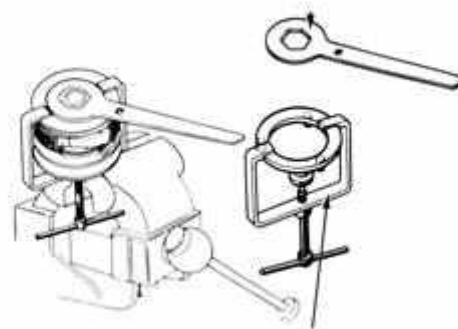
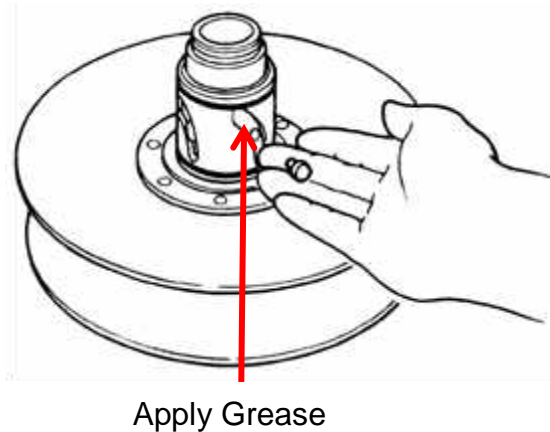
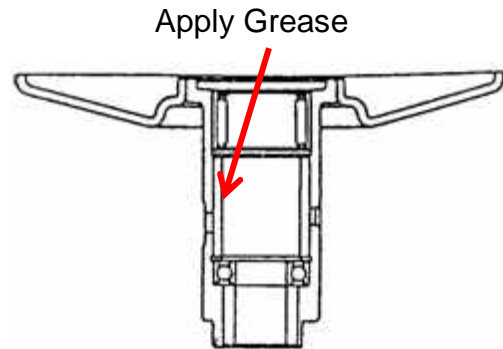

Final Reduction

1.	SCHEMATIC DRAWING	2
2.	SERVICE INFORMATION.....	3
2.1.	General Instructions.....	3
2.2.	Specifications	3
2.3.	Torque Values	3
2.4.	Special Tools.....	3
2.5.	Troubleshooting	3
3.	GEAR OIL	4
3.1.	Draining	4
3.2.	Filling.....	6
4.	FINAL REDUCTION.....	8
4.1.	Removal	8
4.2.	Inspection	9
4.3.	Installation	10
5.	BEARING REPLACEMENT	11
5.1.	Transmission Case Cover.....	11
5.2.	Transmission Case	11

1. SCHEMATIC DRAWING

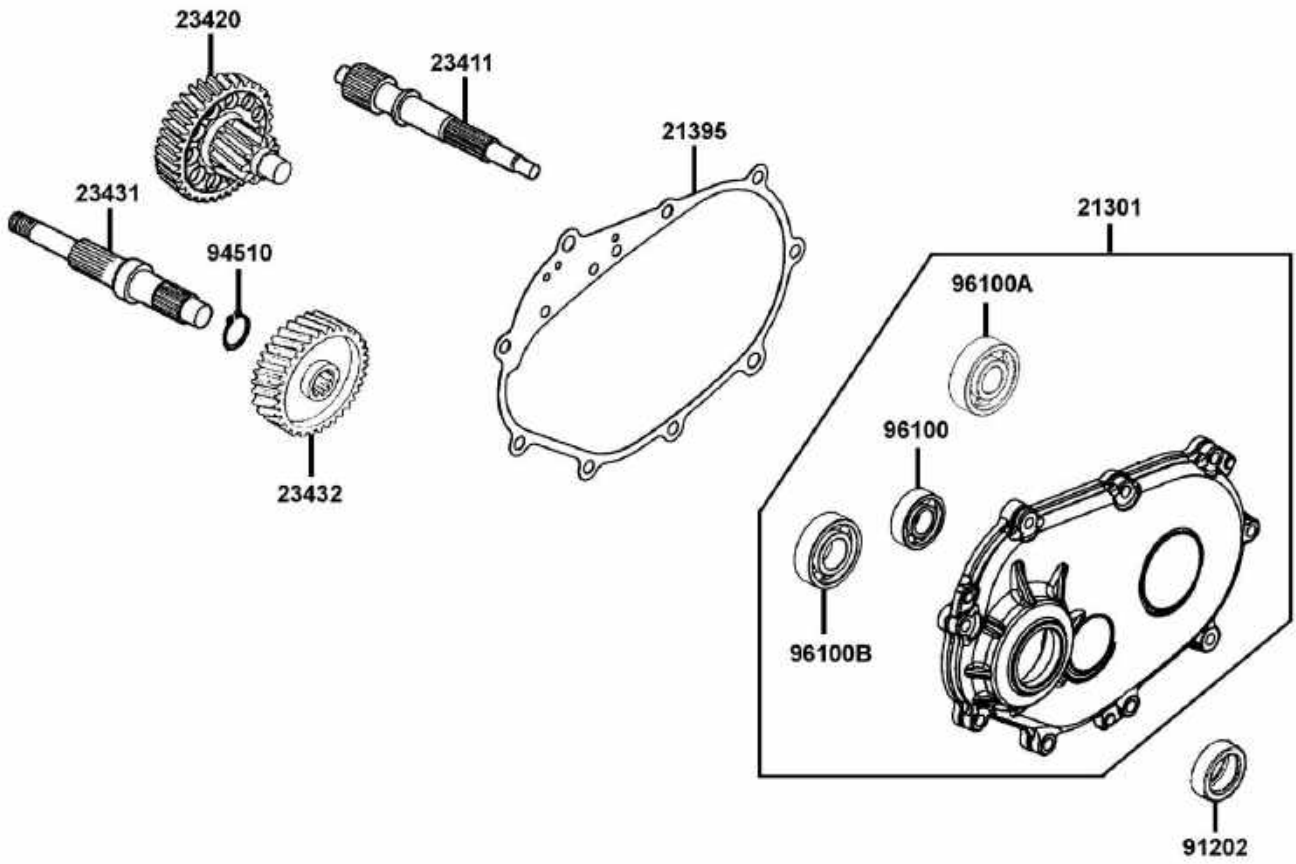

2. SERVICE INFORMATION

2.1. General Instructions

- The servicing operations of this section can be made with the engine installed.
- When replacing the drive shaft, use a special tool to hold the bearing inner race for this operation.

2.2. Specifications

Specified Oil	SAE 90#	
Oil Capacity	At disassembly	0.23 L
	At change	0.20 L

2.3. Torque Values

ITEM	TORQUE (kgf-m)
Transmission case cover bolt	1.0~1.4
L case gear oil filler/ drain bolt	0.8~1.2

2.4. Special Tools

Oil seal and bearing installer	A120E00014
Bearing puller	A120E00037

2.5. Troubleshooting

Engine starts but motorcycle won't move

- Damaged transmission
- Seized or burnt transmission

Abnormal noise

- Worn, seized or chipped gears
- Worn bearing

Oil leaks

- Oil level too high
- Worn or damaged oil seal

3. GEAR OIL

3.1. Draining

Place the vehicle on its center stand on level ground. Place a suitable oil drain pan under the transmission oil drain plug.



Remove the transmission oil level filler bolt with a 12 mm socket.



Place a suitable container under the drain plug to capture the final drive oil. Loosen the oil drain plug with a 12 mm socket. Remove the drain plug and slowly rotate the rear wheel to drain the transmission oil.

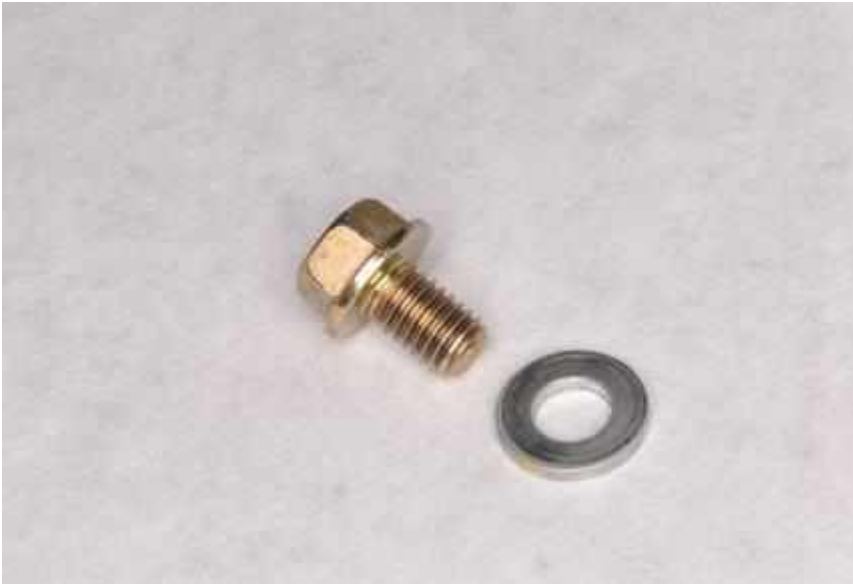

Inspect the drain plug and washer.



Install the oil drain plug and washer with a 12 mm socket. Tighten to specification.

Item	Qty	Thread size (mm)	Torque	
			kgf-m	lb-ft
Final drive oil drain bolt	1	8	0.8 - 1.2	5.79 - 8.68

3.2. Filling



Fill the final drive with the specified quantity of oil with a syringe.

Gear oil type:	SAE 90
Gear oil capacity:	
At disassembly	0.13 Liter
At change	0.12 Liter



Thread in the final drive oil level filler bolt.



Install the oil filler plug and torque it to specification with a 12 mm socket.

Item	Qty	Thread size (mm)	Torque	
			kgf-m	lb-ft
Final drive oil filler bolt	1	8	0.8 - 1.2	5.79 - 8.68

4. FINAL REDUCTION

4.1. Removal

Drain the transmission gear oil into a clean container

Remove the driven pulley

Remove the nine bolts from the transmission case cover, and then remove the transmission case cover.

Remove the dowel pins and gasket.
Remove the final gear and shaft, then remove the countershaft.

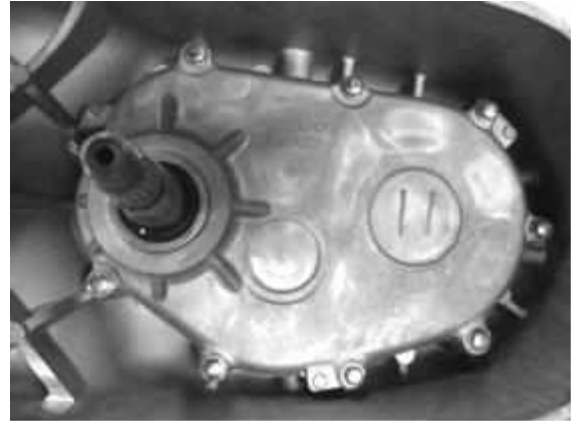

Dowel Pin Gasket Final Gear

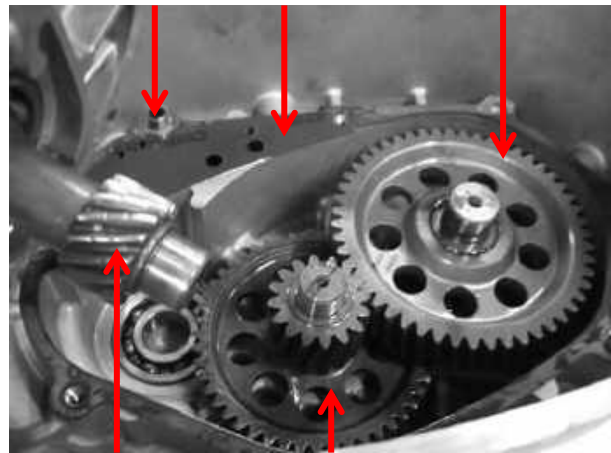

Drive Shaft Counter Shaft

4.2. Inspection

Inspect the countershaft and gear for wear or damage.



Inspect the final gear and final gear shaft for wear, damage or seizure.



Check the driveshaft for wear or damage.

Check the left crankcase bearings for excessive play and inspect the oil seal for wear or damage.

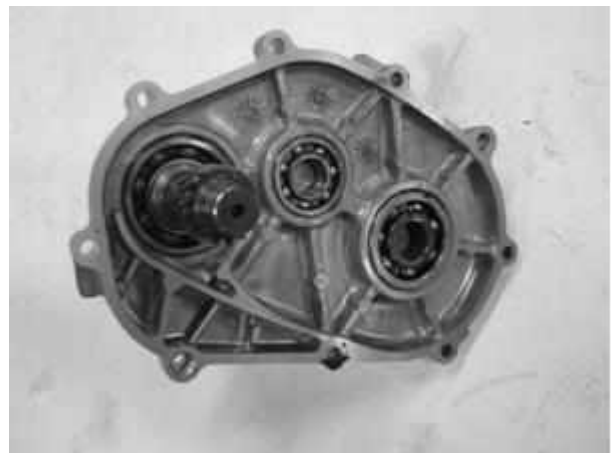

Check the transmission case cover bearings for excessive play and inspect the final shaft bearing oil seal for wear or damage.



Final Gear Shaft Bearing

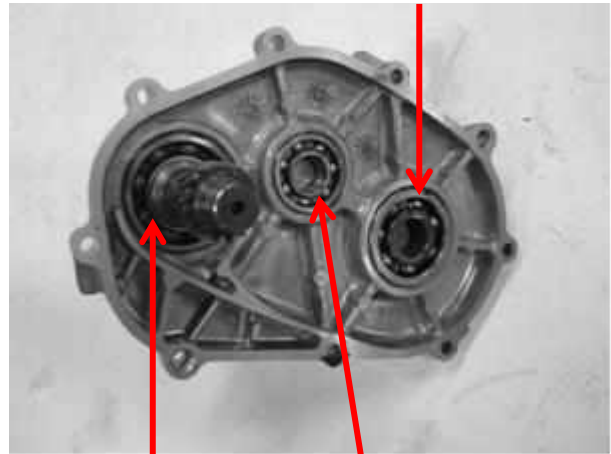

Drive Shaft Bearing

Counter Shaft Bearing

4.3. Installation

Install the final gear and final gear shaft.
 Install the Countershaft
 Install the driveshaft.

Install new gasket.
 Install the two dowel pins.

Dowel Pin Gasket Final Gear

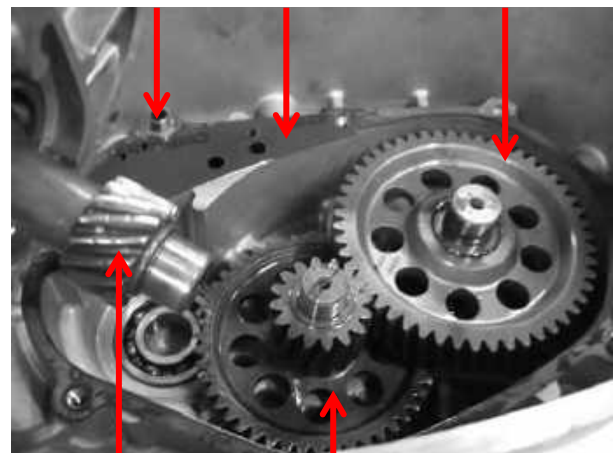

Drive Shaft

Counter Shaft

Install the transmission case cover.
 Install and tighten the nine bolts to the specified torque in a crisscross pattern in 2 or 3 steps.

Torque: 1.0~1.4kgf-m

Fill the transmission case with the specified oil



5. BEARING REPLACEMENT

5.1. Transmission Case Cover

Remove the transmission case cover

Remove the transmission case cover bearings by using the special tool.

Special tool:

Bearing puller A120E00037



Install the new bearings or new oil seal into the transmission case cover by using the special tool.

Special tool:

**Oil seal and bearing installer
A120E00014**

5.2. Transmission Case

Remove the all transmission gears

Remove the transmission case bearings by using the special tool.

Special tool:

Bearing puller A120E00037



Install the new bearings or new oil seal into the transmission case by using the special tool.

Special tool:

**Oil seal and bearing installer
A120E00014**

A.C. Generator & Starter Clutch

1.	Alternator Stator	4
1.1.	Removal.....	4
1.2.	Inspection.....	5
1.3.	Installation.....	5
2.	Starter Clutch	6
2.1.	Removal.....	6
2.2.	Inspection.....	7
2.3.	Installation.....	8

SCHEMATIC DRAWING

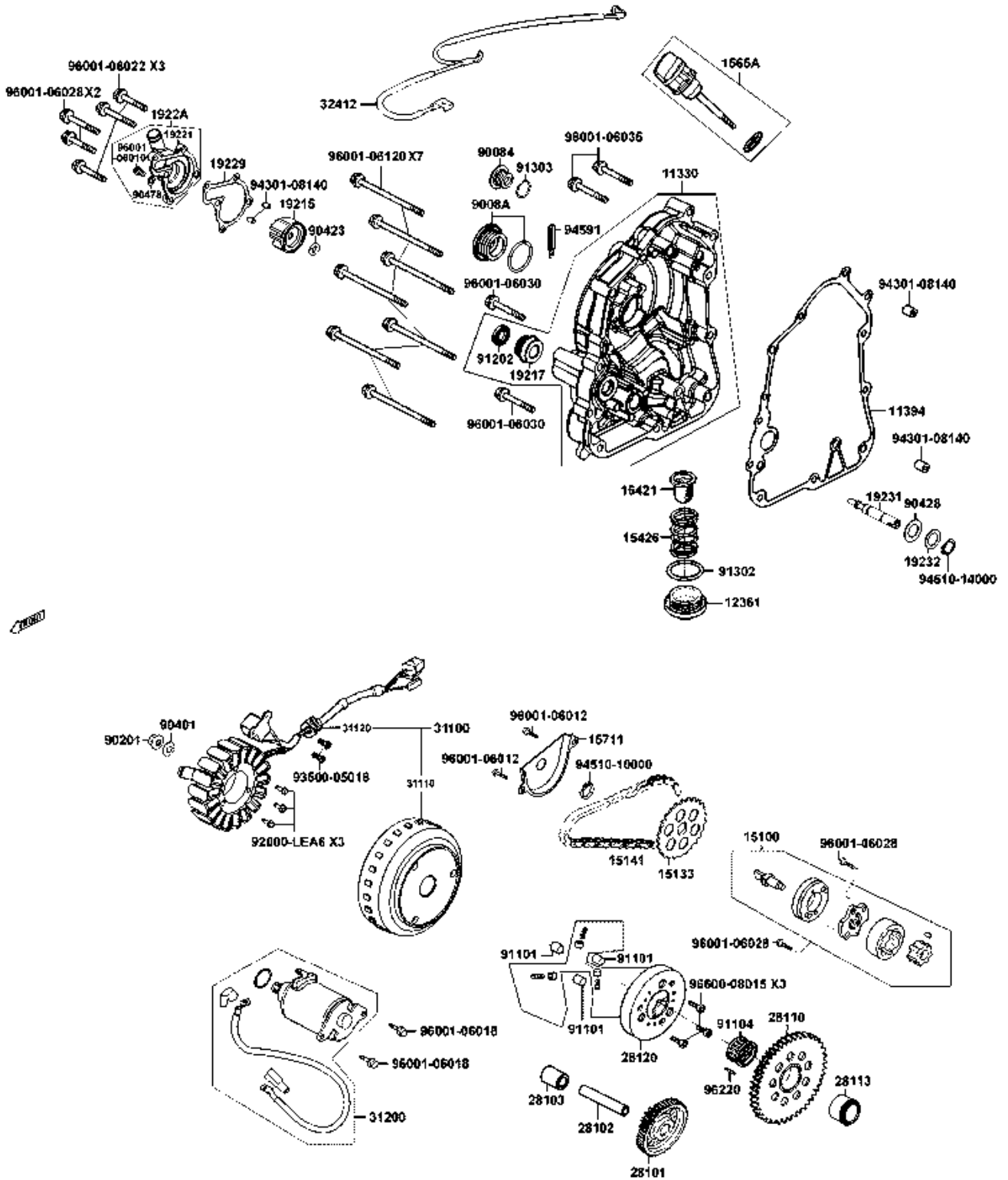

SERVICE INFORMATION

GENERAL INSTRUCTIONS

- All servicing operations and inspections in this section can be made with the engine installed.
- Drain the coolant before removing the right crankcase cover.
- Be careful not to drain the coolant when the engine temperature is high. (Perform this operation when the engine is cold.)
- Drain the coolant into a clean container.
- Drain the engine oil into a clean container before removing the right crankcase cover.
- When the right crankcase cover is installed, fill with the recommended engine oil and coolant. Then, bleed air from the water jacket.
- Refer to chapter 17 for A.C. generator inspection.

SPECIFICATIONS

Engine Oil	SAE 15W/40#
	API-SJ Above
Oil Capacity At Change	1.2 L
Coolant	Distilled Water + Coolant Concentrate
Coolant Capacity	0.87 L

SPECIAL TOOLS

Flywheel Puller	A120E00003
Flywheel Holder	A120E00021

TORQUE VALUES

Flywheel Nut	5.0~6.0 kgf-m
--------------	---------------

TROUBLESHOOTING

Refer to page chapter 17 for A.C. generator troubleshooting.

Starter motor rotates but engine does not start

- Faulty starter clutch
- Starter motor rotates reversely
- Weak battery

1. Alternator Stator

1.1. Removal

Drain the engine oil.

Disconnect the alternator stator connectors.

Remove the 10 bolts from the right crankcase cover and then remove the cover.

Remove the two dowel pins and gasket.

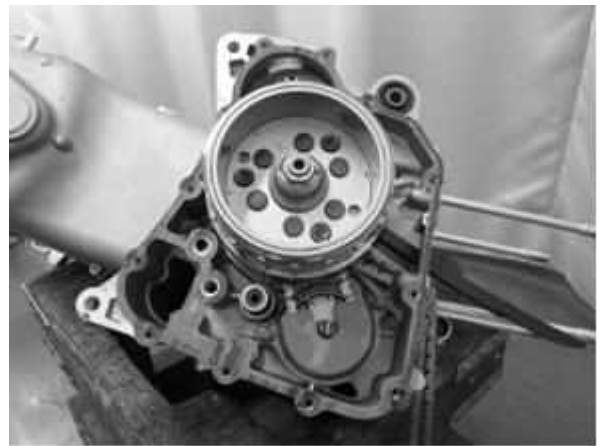

Remove the two pulse coil mount screws.
Remove the three stator mount bolts, grommet and the stator from the right crankcase cover.



1.2. Inspection

Check the stator and pulse coil for damage.

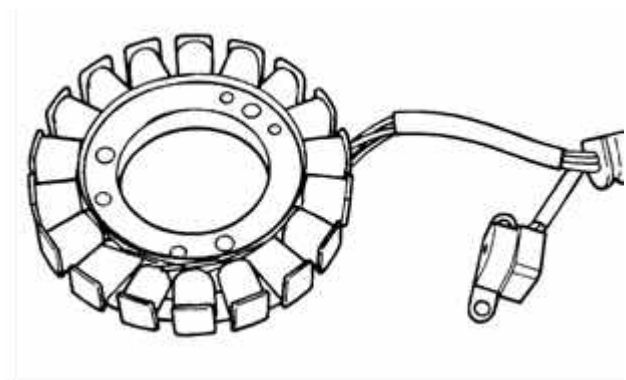

1.3. Installation

Install the stator and tighten the stator mount bolts to the specified torque.

Torque: 1 kgf-m

Apply sealant to the grommet seating surface and install it to the cover groove properly.

Install the pulse coil and tighten mount screws securely.

Clean the mating surfaces of the right crankcase and cover.

Install the dowel pins and gasket.

Install the right crankcase cover and tighten the bolts in a crisscross pattern in 2 or 3 steps.



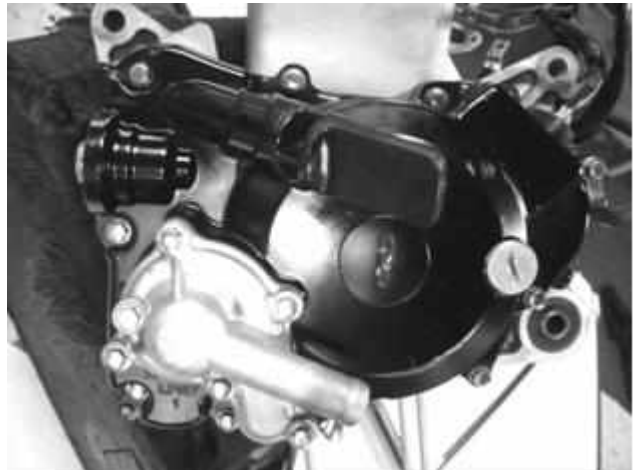

2. Starter Clutch

2.1. Removal

Remove the right crankcase cover.

Hold the flywheel with a special tool and remove the flywheel nut.

Special tool:

Flywheel holder **A120E00021**



Remove the flywheel/driven gear by using the special tool.

Special tool:

Flywheel puller **A120E00003**



Remove the reduction gear shaft and reduction gear.



Remove the starter driven gear.



2.2. Inspection

Install the driven gear into the flywheel.

Check the operation of the spring clutch by turning the driven gear.

You should be able to turn the driven gear clockwise smoothly, but the gear should not turn counterclockwise.



Remove the starter driven gear by turning the driven gear.

Check the starter driven gear teeth for wear or damage.

Measure the starter driven gear boss O.D.

Service limit: 41 mm (1.64 in)

Measure the starter driven gear bushing I.D.

Service limit: 20.15 mm (0.806 in)

Check the starter reduction gear teeth and shaft for wear or damage.



2.3. Installation

Install the starter driven gear onto the crankshaft.



Apply oil to the starter reduction gear shaft.

Install the starter reduction gear and shaft to the right crankcase.



Install the flywheel onto the crankshaft by aligning the key on the crankshaft with the groove in the flywheel.

- * **Before installation, check and make sure that the inside of the flywheel is not contaminated.**



Hold the flywheel with the special tool and tighten the flywheel nut.

Torque: 5.0~6.0 kgf-m

Special tool:

Flywheel holder A120E00021



Install the dowel pins and gasket.

Install the right crankcase cover and tighten the bolts in a crisscross pattern in 2 or 3 steps.



Crank Case & Crank Shaft

1. Schematic Drawing	2
2. Service Information	3
2.1. General Instructions.....	3
2.2. Specifications	3
2.3. Torque Values	3
2.4. Troubleshooting	3
3. Crankcase	4
3.1. Splitting.....	4
4. Crankshaft Inspection.....	7
5. Crankcase Assembly	8

1. Schematic Drawing

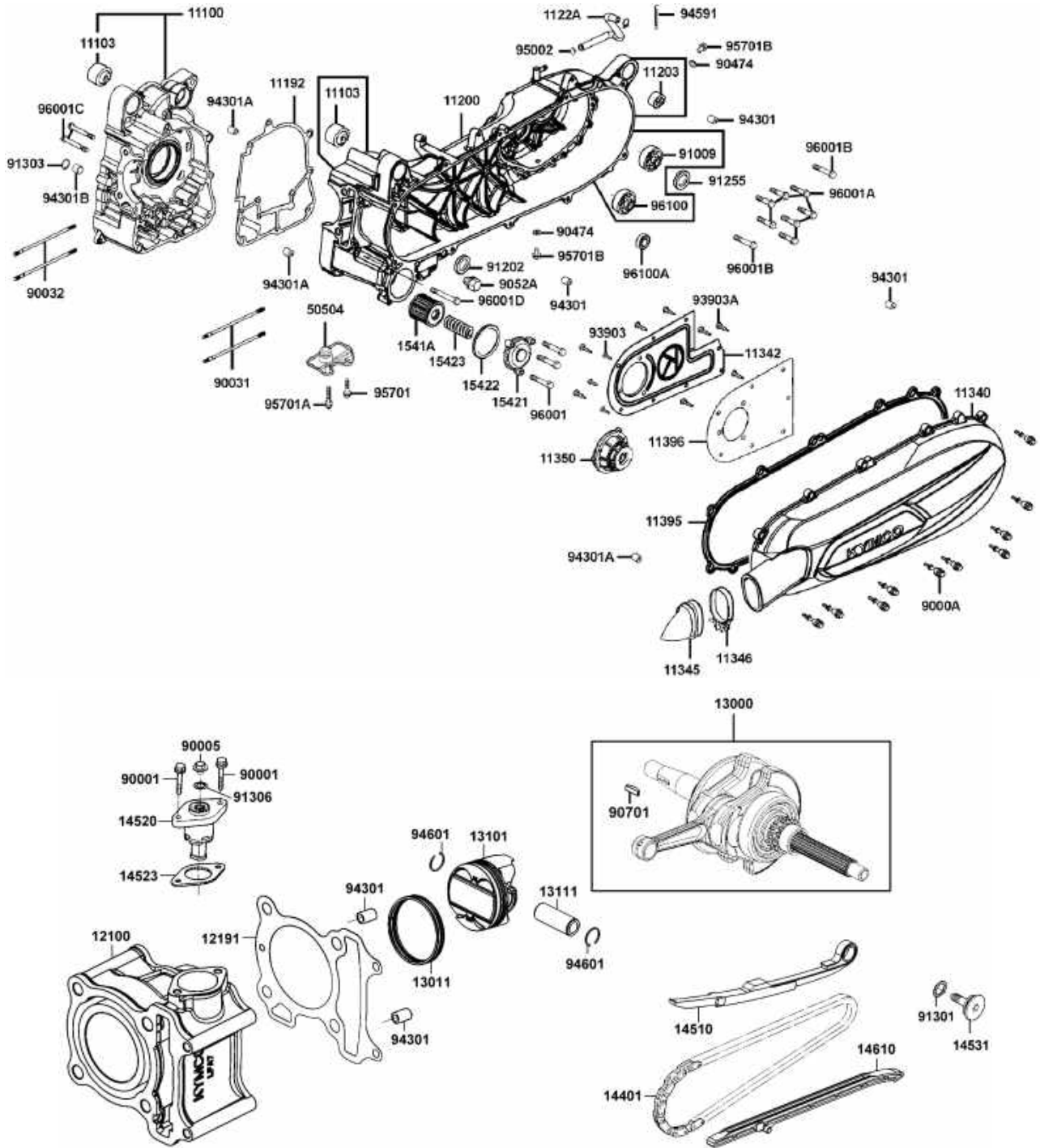

2. Service Information

2.1. General Instructions

- This section covers crankcase separation to service the crankshaft. The engine must be removed for this operation.
- When separating the crankcase, never use a driver to pry the crankcase mating surfaces apart forcedly to prevent damaging the mating surfaces.
- When installing the crankcase, do not use an iron hammer to tap it.
- The following parts must be removed before separating the crankcase.
 - Cylinder head
 - Cylinder/piston
 - Drive and driven pulley
 - A.C. generator/starter clutch
 - Rear wheel/rear shock absorber
 - Starter motor
 - Oil pump

2.2. Specifications

Unit: mm

	Item	Standard	Service Limit
Crankshaft	Connecting rod big end side clearance	0.15~0.35	0.6
	Connecting rod big end radial clearance	0~0.008	0.05
	Run out	---	0.1

2.3. Torque Values

Crankcase bolt	0.8~1.2 kgf-m
Cam chain tensioner pivot	0.8~1.2 kgf-m

2.4. Troubleshooting

Excessive engine noise

- Excessive bearing play
- Excessive crankpin bearing play
- Worn piston pin and piston pin hole

3. Crankcase

SAFETY FIRST: Protective gloves and eyewear are recommended at this point.

3.1. Splitting

Drain the engine oil and remove the strainer screen. See the Engine Oil topic for more information.

Remove the engine. See the Engine Removal topic for more information.

Remove the cylinder head cover. See the Cylinder Head Cover topic for more information.

Remove the camshaft sprocket. See the Camshaft topic for more information.

Remove the cylinder head. See the Cylinder Head topic for more information.

Remove the cylinder and piston. See the Cylinder and Piston topic for more information.

Remove the generator cover, flywheel, starter idle gear and starter driven gear. See the A.C. Generator and Starter clutch topic.

Remove the starter motor. See the Starter Motor topic for more information.

Remove the oil pump. See the Oil Pump topic for more information.

Remove the CVT pulleys and belt. See the CVT Removal topic for more information.

Remove the rear wheel. See the Rear Wheel topic for more information.

11. Crank Case & Crank Shaft

Remove the cam chain tensioner slipper bolt.

Remove the cam chain tensioner slipper and cam chain.

Remove the two right crankcase attaching bolts.



Remove the left crankcase bolts.

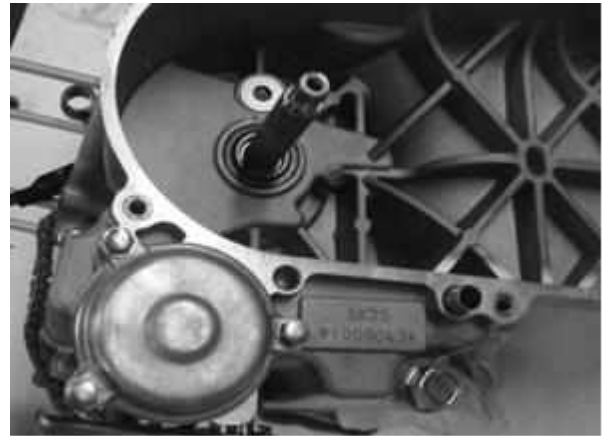

Place the crankcase with the left crankcase down and remove the right crankcase from the left crankcase.

※ Never use a driver to pry the crankcase mating surfaces apart.

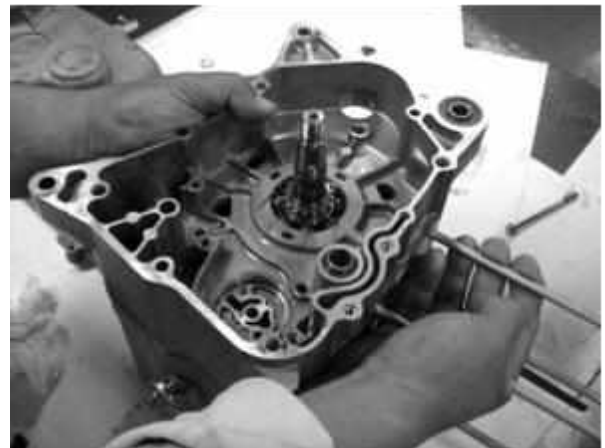

Remove the gasket and dowel pins.

Remove the crankshaft from the left crankcase.



11. Crank Case & Crank Shaft

Remove the oil seal from the left crankcase.

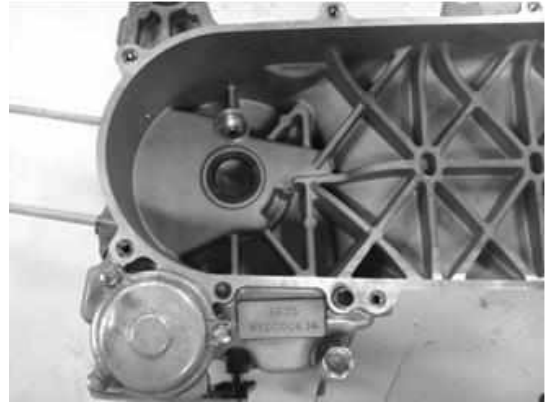

4. Crankshaft Inspection

Measure the connecting rod big end side clearance.

Service Limit: 0.6 mm



Measure the connecting rod small end I.D.

Service Limit: 14.06 mm



Measure the crankshaft run-out.

Service Limit: 0.1 mm



Measure the crankshaft bearing play.

Service Limits:

Axial: 0.2 mm

Radial: 0.05 mm

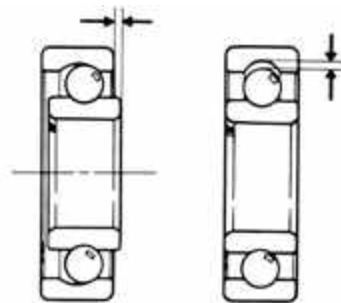

5. Crankcase Assembly

Clean off all gasket material from the crankcase mating surfaces.

- ※ **Avoid damaging the crankcase mating surfaces.**



Install a new oil seal into the left crankcase.



Place the left crankcase down and install the crankshaft into the left crankcase.

- ※ **Avoid damaging the oil seal.**
- ※ **Apply grease to the lip of the oil seal.**



Install the two dowel pins and a new gasket. Place the right crankcase over the crankshaft and onto the left crankcase.

- ※ **Install the right crankcase squarely and do not tap it with an iron or plastic hammer.**



11. Crank Case & Crank Shaft

Install and tighten the right and left crankcase attaching bolts.

Torque: 1.0 kgf-m

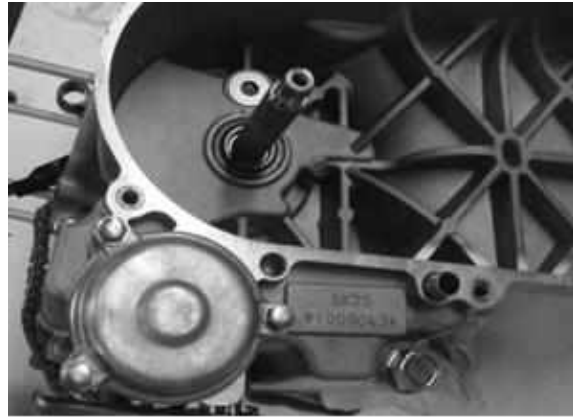

Install the cam chain.

Install the cam chain tensioner slipper.

Install and tighten the cam chain tensioner slipper bolt.

Torque: 1.0kgf-m



Cooling System

1.	SCHEMATIC DRAWING	2
2.	SERVICE INFORMATION	2
2.1.	General Instructions	2
2.2.	Special Tool	2
2.3.	Torque Values	2
2.4.	Troubleshooting	3
2.5.	Specifications	3
2.6.	Coolant Gravity	4
2.7.	Coolant Mixture (With Anti-Rust And Anti-Freezing Effects)	4
3.	RADIATOR CAP INSPECTION	5
4.	COOLANT REPLACEMENT	6
4.1.	Preparation	6
4.2.	Replacement	6
4.3.	Air Bleeding	7
5.	RADIATOR	8
5.1.	Removal	8
5.2.	Inspection	9
5.3.	Installation	9
6.	WATER PUMP	10
6.1.	Mechanical Seal (Water Seal) Inspection	10
6.2.	Water Pump/Impeller Removal	10
6.3.	Water Pump Shaft Removal	12
6.4.	Water Pump/Impeller Installation	13
7.	WATER TEMPERATURE SENSOR	14
7.1.	Removal	14
7.2.	Inspection	14
7.3.	Installation	15
8.	THERMOSTAT	16
8.1.	Removal	16
8.2.	Installation	16
8.3.	Disassembly	16
8.4.	Inspection	17
8.5.	Assembly	17

1. SCHEMATIC DRAWING

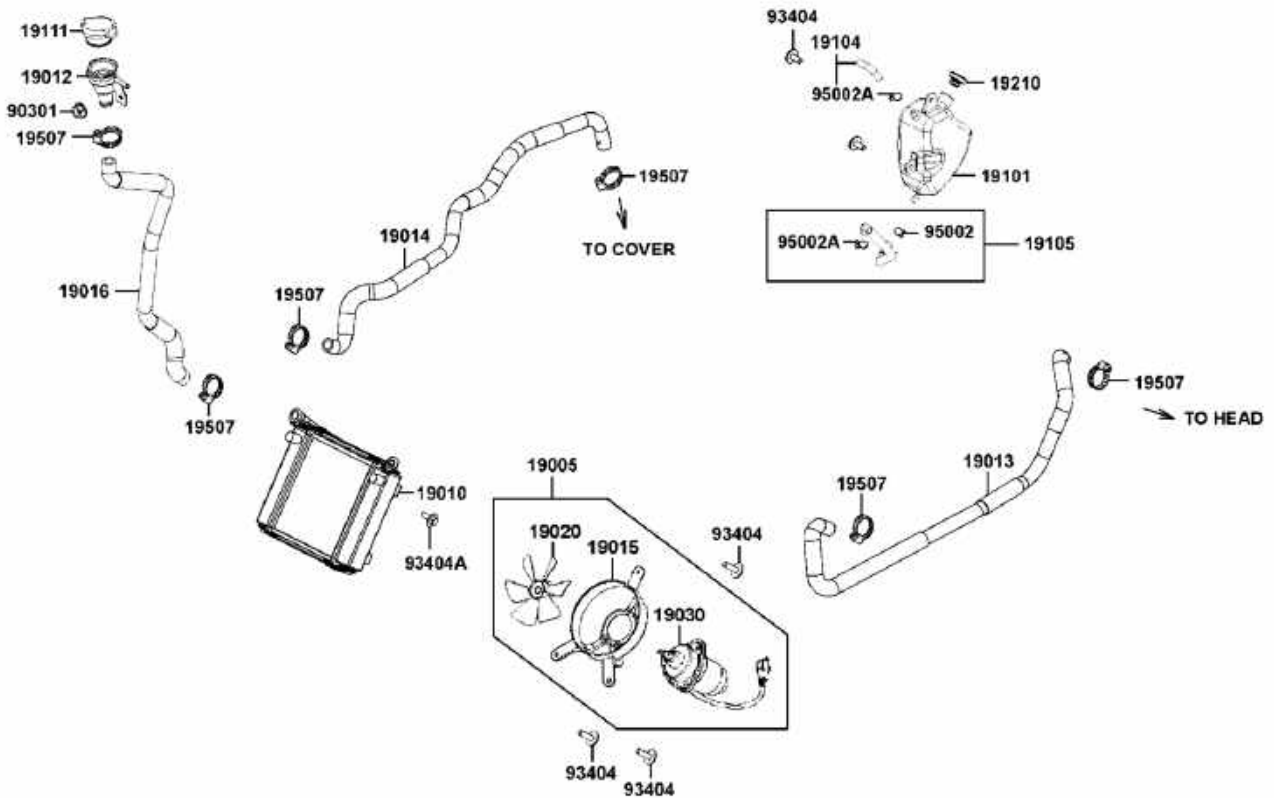

2. SERVICE INFORMATION

2.1. General Instructions

- The water pump must be serviced after removing the engine. Other cooling system service can be done with the engine installed in the frame.
- The engine must be cool before servicing the cooling system.
- When the coolant temperature is over 100°C, never remove the radiator cap to release the pressure because the boiling coolant may cause danger.
- Avoid spilling coolant on painted surfaces because the coolant will corrode the painted surfaces. Wash off any spilled coolant with fresh water as soon as possible.
- After servicing the system, check for leaks with a cooling system tester.

2.2. Special Tool

Mechanical seal driver

2.3. Torque Values

Water pump impeller	1.2 kgf-m	Left hand threads
Water pump cover bolt	1.0 kgf-m	

2.4. Troubleshooting

Engine temperature too high

- Faulty temperature gauge or thermo sensor
- Faulty radiator cap
- Faulty thermostat
- Insufficient coolant
- Passages blocked in hoses or water jacket
- Clogged radiator fins
- Passages blocked in radiator
- Faulty water pump

Temperature gauge pointer does not register the correct coolant temperature

- Faulty temperature gauge or thermo sensor
- Faulty thermostat

Coolant leaks

- Faulty pump mechanical (water) seal
- Deteriorated O-rings
- Damaged or deteriorated water hoses

2.5. Specifications

Radiator cap relief pressure		90±14.7 kPa (0.92±0.15 kgf/cm ² , 13.05±2.13 psi)
Thermostat temperature	Begins to open	82°C (180°F)
	Full-open	95°C (203°F)
	Valve lift	3.5~4.5 mm (0.14~0.18 in) minimum
Coolant Capacity	Coolant radiator and the hoses	870 cc
	Reserve tank	490 cc
	Total	1360 cc
Standard coolant concentration		1:1 mixture with soft water

2.6. Coolant Gravity

Temp. °C	0	5	10	15	20	25	30	35	40	45	50
Coolant concentration											
5%	1.009	1.009	1.008	1.008	1.007	1.006	1.005	1.003	1.001	0.009	0.997
10%	1.018	1.107	1.017	1.016	1.015	1.014	0.013	1.011	1.009	1.007	1.005
15%	1.028	1.027	1.026	1.025	1.024	1.022	1.020	1.018	1.016	1.014	1.012
20%	1.036	1.035	1.034	1.033	1.031	1.029	1.027	1.025	1.023	1.021	1.019
25%	1.045	1.044	1.043	1.042	1.040	1.038	1.036	1.034	1.031	1.028	1.025
30%	1.053	1.051	1.051	1.049	1.047	1.045	1.043	1.041	1.038	1.035	1.032
35%	1.063	1.062	1.060	1.058	1.056	1.054	1.052	1.049	1.046	1.043	1.040
40%	1.072	1.070	1.068	1.066	1.064	1.062	1.059	1.056	1.053	1.050	1.047
45%	1.080	1.078	1.076	1.074	1.072	1.069	1.056	1.063	1.062	1.057	1.054
50%	1.086	1.084	1.082	1.080	1.077	1.074	1.071	1.068	1.065	1.062	1.059
55%	1.095	1.093	1.091	1.088	1.085	1.082	1.079	1.076	1.073	1.070	1.067
60%	1.100	1.098	1.095	1.092	1.089	1.086	1.083	1.080	1.077	1.074	1.071

2.7. Coolant Mixture (With Anti-Rust And Anti-Freezing Effects)

Freezing Point	Mixing Rate
-9°C	20%
-15°C	30%
-25°C	40%
-37°C	50%
-44.5°C	55%

Cautions for Using Coolant:

Use coolant of specified mixing rate. (The mixing rate of 425cc KYMCO SIGMA coolant concentrate + 975cc distilled water is 30 %.)

Do not mix coolant concentrate of different brands.

Do not drink the coolant which is poisonous.

The freezing point of coolant mixture shall be 5°C lower than the freezing point of the riding area.

3. RADIATOR CAP INSPECTION

SAFETY FIRST: Protective gloves and eyewear are recommended at this point.

- ※ Removing the radiator cap while the engine is hot can cause the coolant to spray out, seriously scalding you.
- ※ Allow the engine sufficient time to cool before handling or working on the cooling system components.

Remove the radiator cap in two stages. Allow any built up pressure to vent and then open the cap all the way and remove it.



Radiator cap

After remove the radiator cap, wet the tester seal, and install the end of the pressure tester onto the filler neck. Pump the tester up until the gauge reads 0.84 kg/cm² or 12 psi. The cooling system should hold this pressure for at least 6 seconds.

Replace the radiator cap if it does not hold pressure, or if relief pressure is too high or too low.

It must hold the specified pressure for at least 6 seconds.

- ※ Before installing the cap in the tester, wet the sealing surface.
- ※ Excessive pressure can damage the cooling system components.
- ※ Do not exceed 105 kPa (1.05 kg/cm², 14.9 psi).

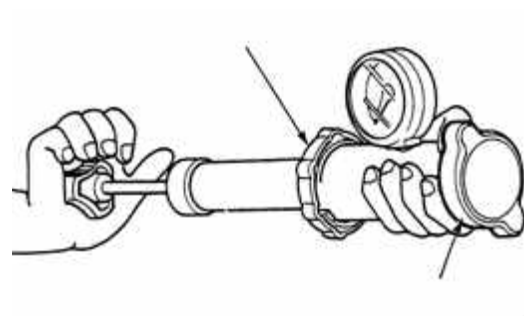

Radiator Cap Relief Pressure:
90 kPa (0.9 kg/cm², 12.8 psi)

4. COOLANT REPLACEMENT

4.1. Preparation

※ Antifreeze is highly toxic and can kill pets and animals if drank. Do not leave coolant where animals (including children!) can get to it.

- The effectiveness of coolant decreases with the accumulation of rust or if there is a change in the mixing proportion during usage. Therefore, for best performance change the coolant regularly as specified in the maintenance schedule.
- Mix only distilled, low mineral water with the antifreeze.

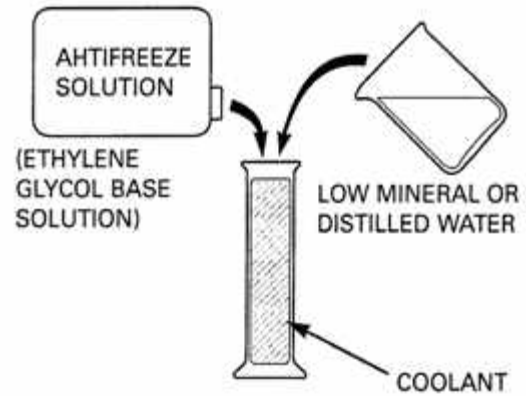

Recommended mixture:

1:1 (Distilled water and antifreeze)

4.2. Replacement

Remove the front cover

※ When filling the system or reserve tank with coolant (checking the coolant level), place the scooter in a vertical position on a flat, level surface.

Remove the radiator cap (1).



(1)

Remove the drain bolt and sealing washer and allow the coolant to drain into a suitable container.

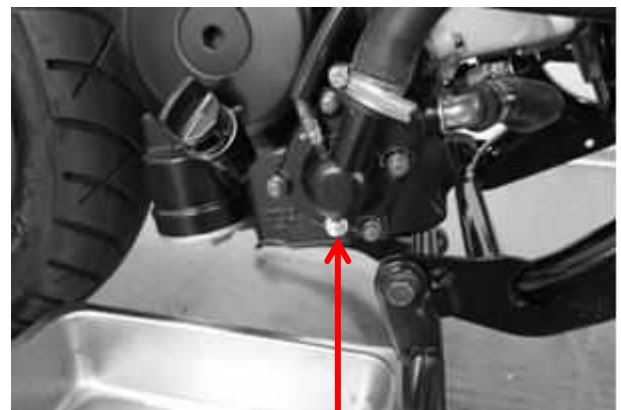

(2)

Remove the screw (3) and reserve tank lid (4).

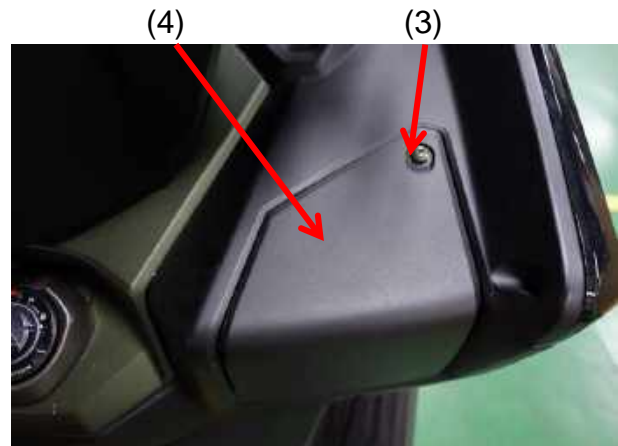

Open the coolant reserve tank lid. Siphon the coolant out of the reserve tank with an appropriate suction device. If a suction device is unavailable remove the reserve tank and pour it out.



When the coolant has finished draining return the drain bolt to the water pump with a new sealing washer.

Fill the reserve tank to the upper level line.

Fill the system with the recommended coolant through the filler opening up to the filler neck.

Gently rock the vehicle side-to-side to release any air bubbles trapped in the cooling system.



4.3. Air Bleeding

Bleed air from the system as follow:

1. Start the engine and let it idle for 2–3 minutes.
2. Snap the throttle three to four times to bleed air from the system.
3. Stop the engine and add coolant to the proper level if necessary. Reinstall the radiator cap.
4. Check the level of coolant in the reserve tank and fill to the upper level if it is low.

5. RADIATOR

5.1. Removal

Drain the coolant.

Disconnect the siphon hose (1) and air bleed hose (2).

Remove the nut (3).

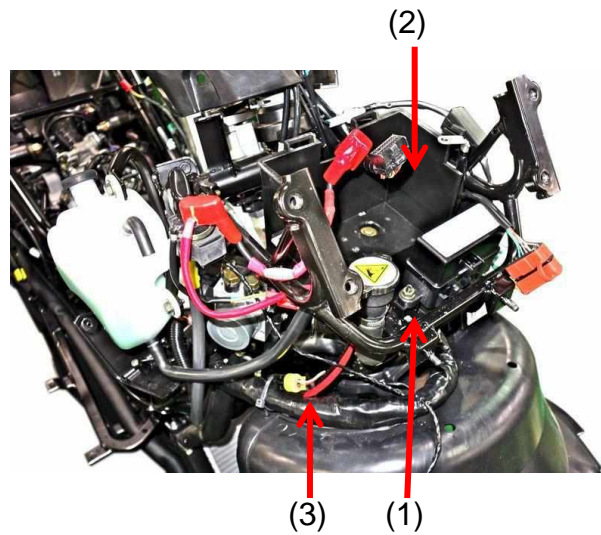

Loosen the hose bands, and then disconnect the output hose (4) (to the water pump), coolant filling hose (5) and input hose (6) (from the engine) from the radiator.

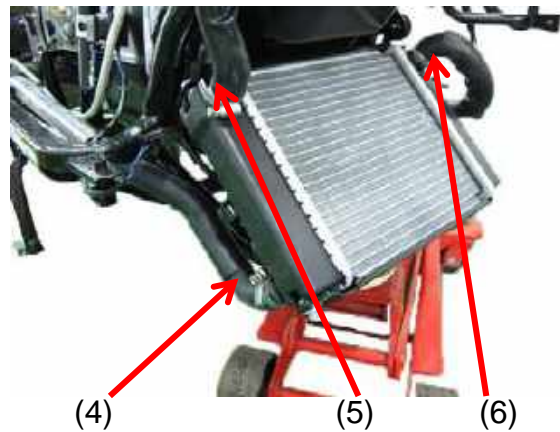

Disconnect the fan motor switch connector.

Remove the bolts and then remove the radiator from frame.



5.2. Inspection

Inspect the radiator fins for damage and clogging. To remove the fan, take out the three mounting bolts with a 10 mm socket.

Clean out the fins with low pressure compressed air and water.

Check the radiator for any bent or damaged fins. Use a small flat blade screwdriver to straighten them out, but be careful not to puncture the radiator.



※ Always wear safety glasses when using compressed air and never point it directly at yourself or anyone else.

Check the fan motor to operate using an available battery.



5.3. Installation

Installation is in the reverse order of removal.

Refill the coolant.

6. WATER PUMP

6.1. Mechanical Seal (Water Seal) Inspection

Inspect the telltale hole for signs of mechanical seal coolant leakage.

If the mechanical seal is leaking, remove the right crankcase cover and replace the mechanical seal.

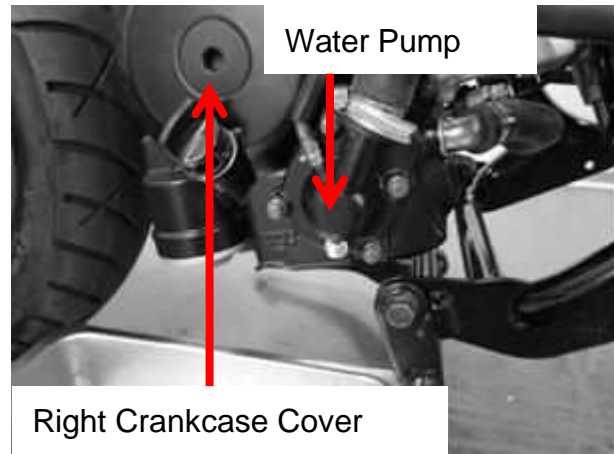

6.2. Water Pump/Impeller Removal

Drain the coolant.

Remove the coolant inlet hose and outlet hose.

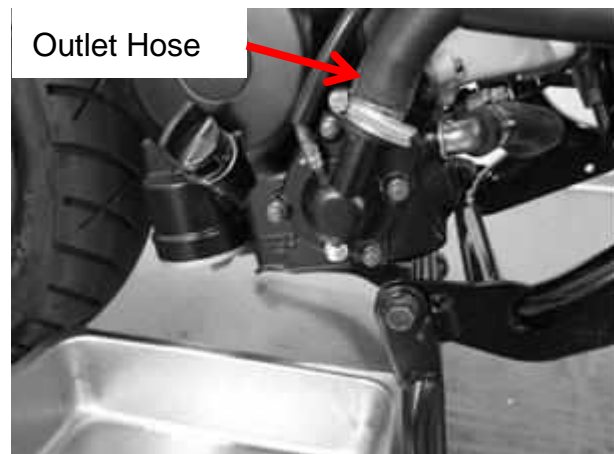
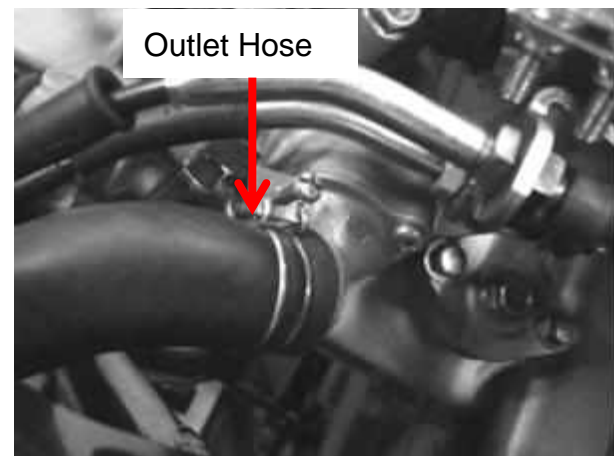

12. COOLING SYSTEM

Remove the four bolts and the water pump cover, gasket and 2 dowel pins.

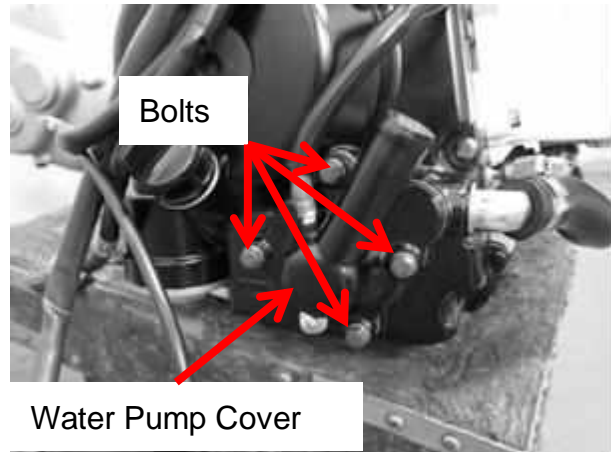

Remove the water pump impeller.

※ **The impeller has left hand threads.**

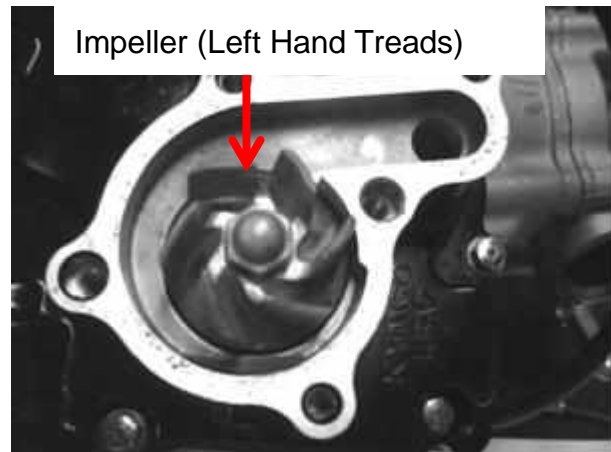

Inspect the mechanical (water) seal and seal washer for wear or damage.

※ **The mechanical seal and seal washer must be replaced as a set.**

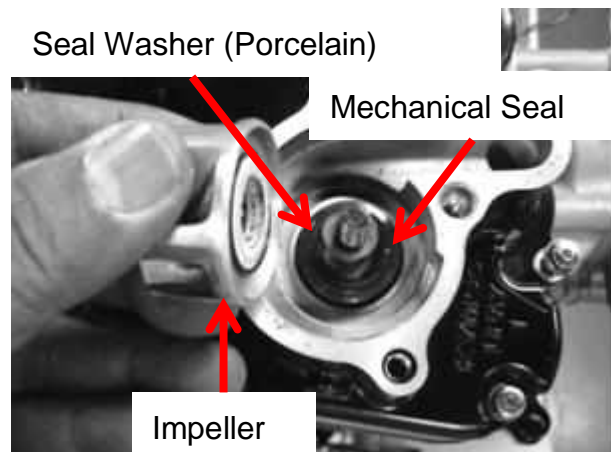

6.3. Water Pump Shaft Removal

Disconnect the water hose from the right crankcase cover.

Remove the 5 bolts attaching the water pump assembly.

Remove the water pump assembly, gasket and dowel pins.



Remove the water pump shaft clip and water pump shaft

Install the water pump shaft and shaft inner bearing into the water pump assembly.

Install the snap ring to secure the inner bearing properly.



Install the dowel pins and a new gasket and then install the water pump assembly to the right crankcase cover.

Tighten the 5 bolts to secure the water pump assembly.

※ When installing the water pump assembly, aligning the groove on the water pump shaft with the tab on the oil pump shaft.



6.4. Water Pump/Impeller Installation

When the mechanical seal is replaced, a new seal washer must be installed to the impeller.

Install the impeller onto the water pump shaft.

Torque: 1.2 kgf-m (12 N-m, 9 lbf-ft)

※ The impeller has left hand threads.

Install the two dowel pins and a new gasket.

Install the water pump cover and tighten the 4 bolts.

Torque: 1 kgf-m (10 N-m, 7 lbf-ft)

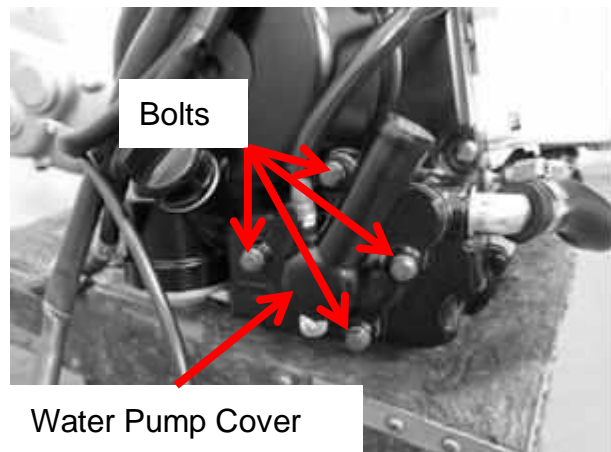
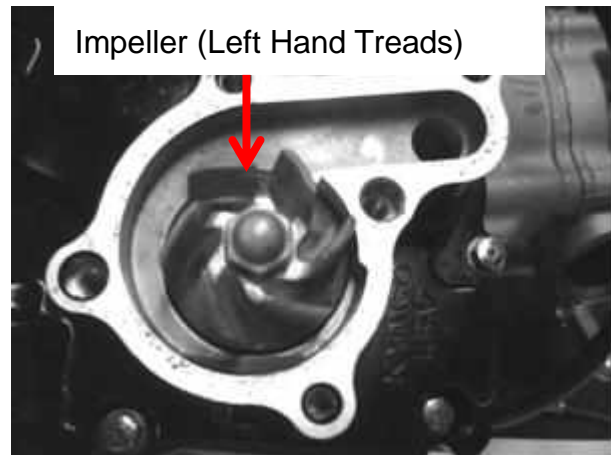
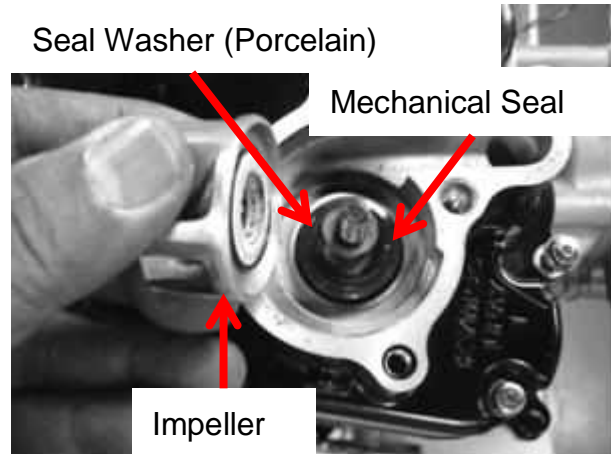

7. WATER TEMPERATURE SENSOR

7.1. Removal

Remove the luggage box.

Drain the coolant.

Disconnect the water temperature sensor connectors.

Remove the water temperature sensor from thermostat.



7.2. Inspection

Connect the water temperature sensor to the ohmmeter and dip it in oil contained in a pan which is placed on an electric heater.

Gradually raise oil temperature while reading the thermometer in the pan and the ohmmeter connected. If the resistance measured is out of specification, replace the temperature gauge with a new one.

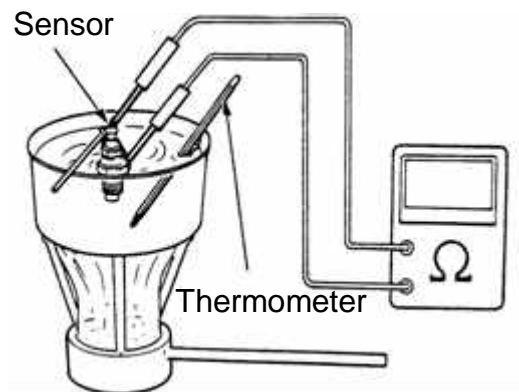

Temperature	Standard resistance
50°C	123.9–478.9 Ω
100°C	26–29.3 Ω

※ Handle the water temperature sensor carefully as it is vulnerable to impact.

※ Do not allow the water temperature sensor and the thermometer to come in contact with the bottom of the pan.

7.3. Installation

With thread lock applied to the threaded part, tighten the water temperature sensor.

Torque: 0.8 kgf-m (8 N-m, 5.8 lbf-ft)

Connect the sensor connectors.

After the water temperature sensor has been installed, fill coolant and perform air bleeding

8. THERMOSTAT

8.1. Removal

Drain the coolant.

Remove the luggage box.

Disconnect the water hose (1) from the thermostat housing.

Remove the mounting bolts (2) and the thermostat housing from the cylinder head.

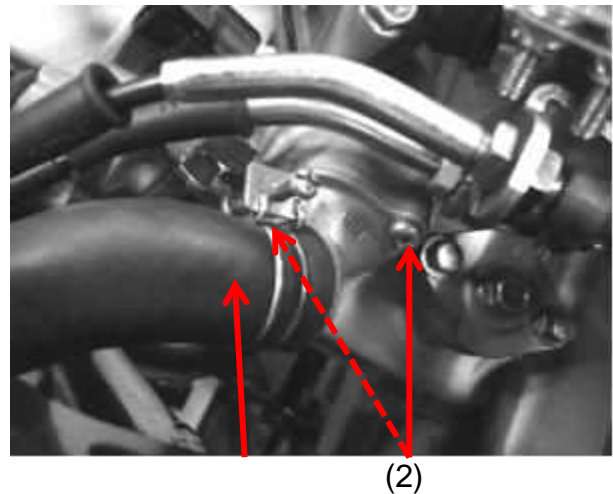

(2)

8.2. Installation

The installation sequence is the reverse of removal.

After the water thermostat has been installed, fill coolant and perform air bleeding.

8.3. Disassembly

Remove the two bolts and separate the thermostat housing halves.

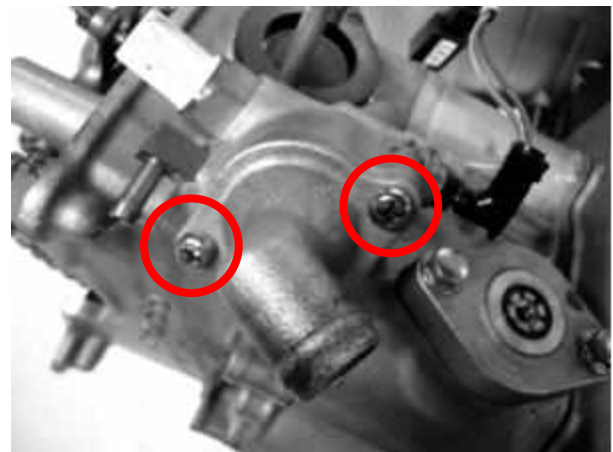

Remove the thermostat from the thermostat housing.

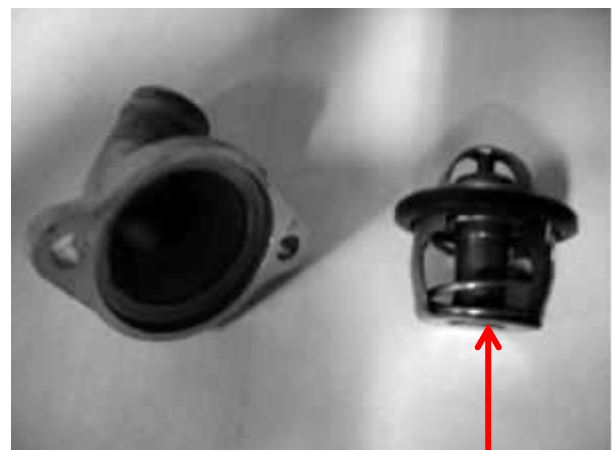

Thermostat

8.4. Inspection

Suspend the thermostat in a pan of water over a burner and gradually raise the water temperature to check its operation.

Technical Data

Begins to open	80 - 82°C (176 - 180°F)
Full-open	90°C (198°F)
Valve lift	3.5 mm (0.14 in) minimum

- ※ Do not let the thermostat touch the pan as it will give a false reading.
- ※ Replace the thermostat if the valve stays open at room temperature.
- ※ Test the thermostat after it is opened for about 5 minutes and holds the temperature at 70°C.

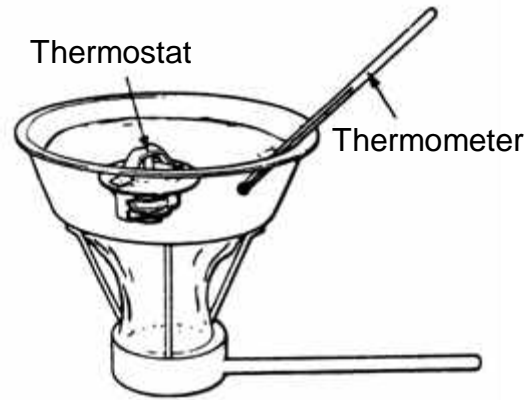

8.5. Assembly

Thermostat assembly is in the reverse order of disassembly.



Front Assembly

1.	SCHEMATIC DRAWING	2
2.	SERVICE INFORMATION.....	4
2.1.	GENERAL INSTRUCTIONS.....	4
2.2.	SPECIFICATIONS	4
2.3.	TORQUE VALUES.....	4
2.4.	SPECIAL TOOLS.....	5
2.5.	TROUBLESHOOTING.....	5
3.	Front Wheel.....	6
3.1.	Removal	6
3.2.	Inspection	6
3.3.	Disassembly	7
3.4.	Assembly	8
4.	Front Brake Fluid.....	9
4.1.	Check	9
4.2.	Fluid Replacement/Air Bleeding.....	9
4.3.	Brake Fluid Draining	9
4.4.	Brake Fluid Filling/Air Bleeding	10
5.	Front Brake Pad	11
5.1.	Brake Pad Replacement	11
6.	Brake Disc.....	12
6.1.	Inspection	12
6.2.	Removal	12
7.	Handlebar.....	13
7.1.	Removal	13
7.2.	Installation	13
7.3.	Disassembly	14
7.4.	Assembly.....	15
8.	Front Shock Absorber.....	16
8.1.	Removal	16
8.2.	Inspection	16
9.	Steering Stem	17
9.1.	Removal	17
9.2.	Installation	19

1. SCHEMATIC DRAWING

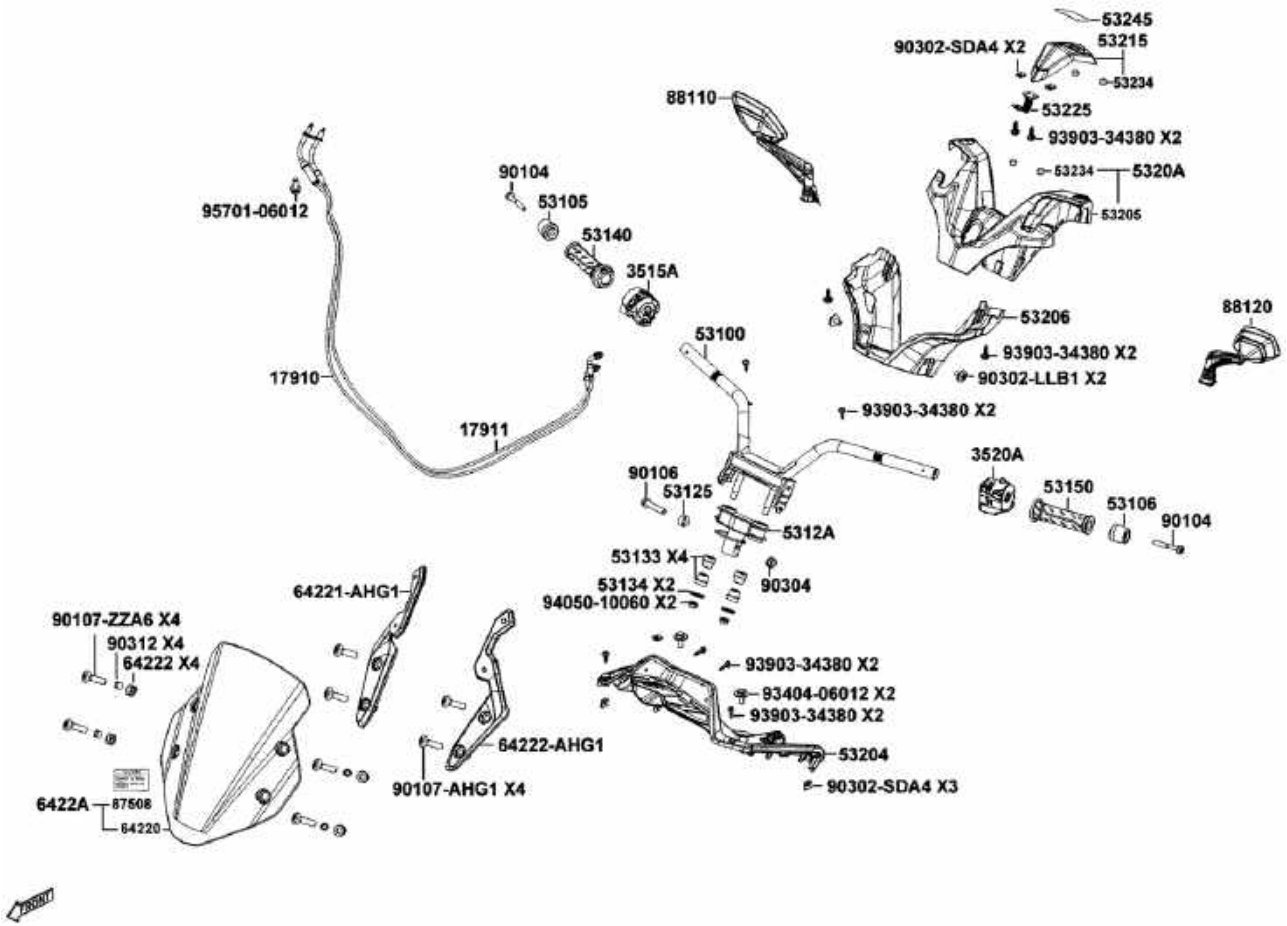

14. FRONT ASSEMBLY

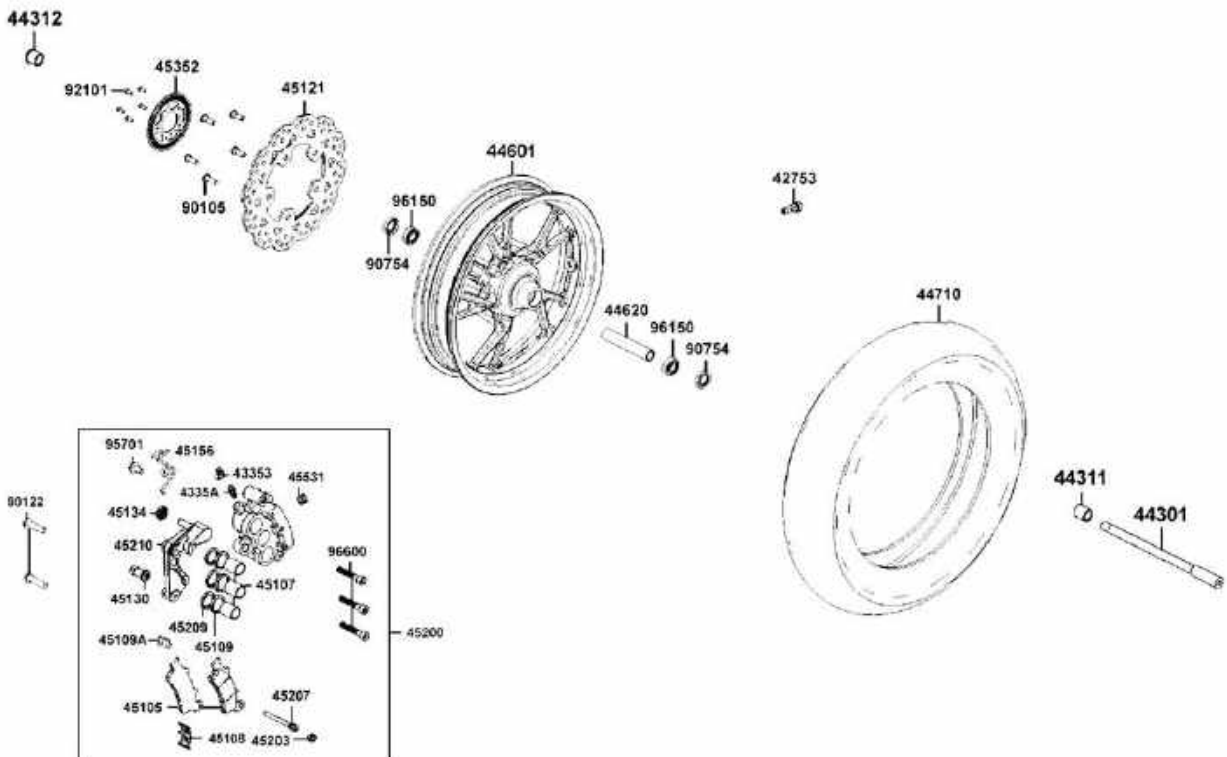
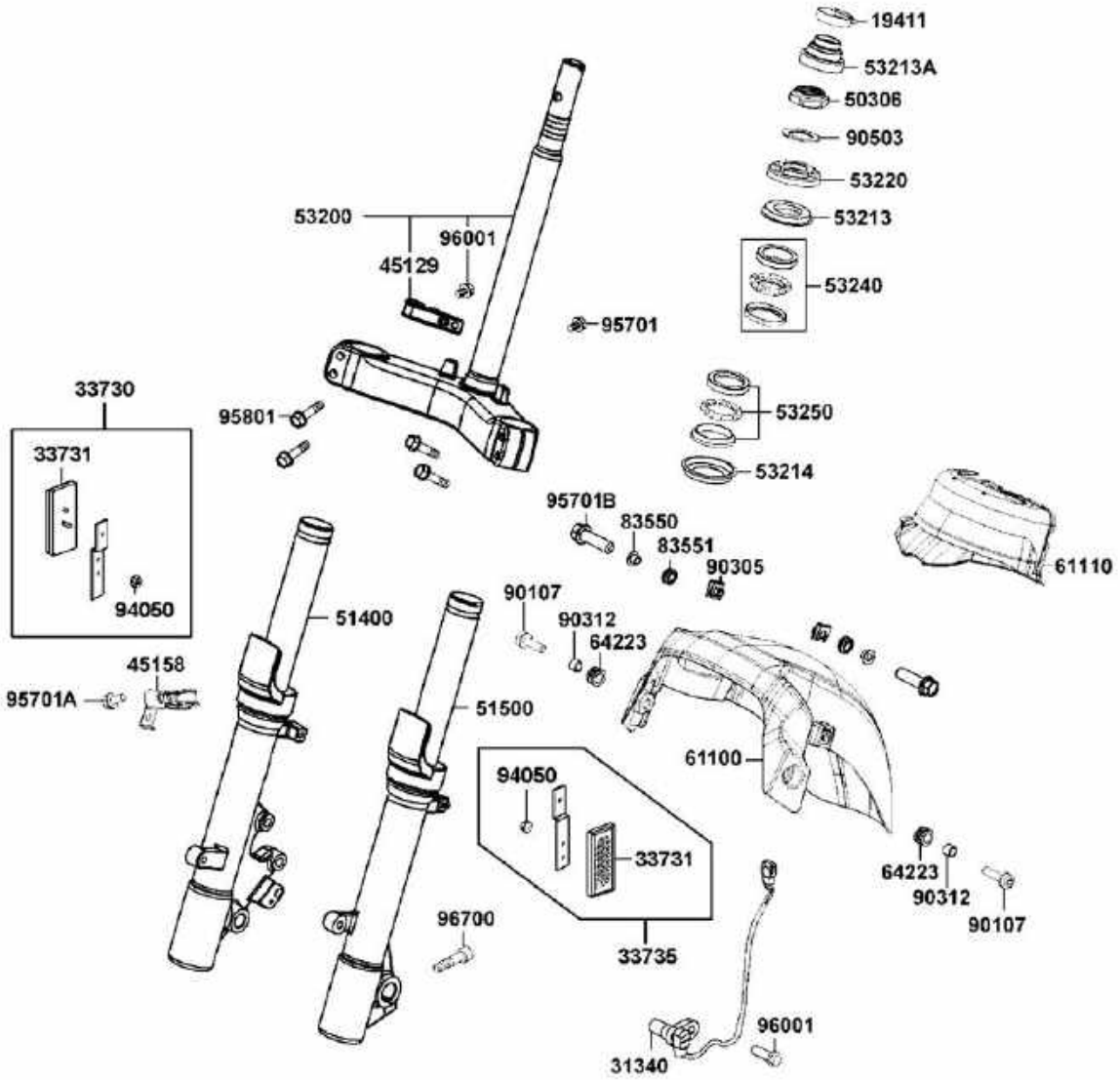

2. SERVICE INFORMATION

2.1. GENERAL INSTRUCTIONS

- Remove the motorcycle frame covers before removing the front wheel, steering handlebar, front shock absorber and front fork. Jack the motorcycle front wheel off the ground and be careful to prevent the motorcycle from falling down.
- During servicing, keep oil or grease off the brake pads and brake disk.

2.2. SPECIFICATIONS

Unit: mm (in)

Item		Standard	Service Limit
Axle Shaft Runout		---	0.2
Front Wheel Rim Runout	Radial	---	2.0
	Axial	---	2.0
Brake Disk Thickness		4.0	3.0
Brake Disk Runout		---	0.3
Brake Master Cylinder I.D.		12.7~12.74	
Brake Master Cylinder Piston O.D.		12.65~12.68	
Brake Caliper Piston O.D.		25.33~25.36	
Brake Caliper Cylinder I.D.		25.4~25.45	

2.3. TORQUE VALUES

Handlebar Lock Nut	45 N•m (4.5 kgf•m)	
Steering Stem Lock Nut	70 N•m (7.0kgf•m)	
Steering Stem Pinch Bolt	27 N•m (2.7 kgf•m)	
Front Axle	20 N•m (2.0 kgf•m)	
Master cylinder reservoir cover screw	1.6N•m (0.16 kgf•m)	
Master cylinder holder bolt	12 N•m (1.2 kgf•m)	
Brake lever pivot bolt	2 N•m (0.2 kgf•m)	
Brake lever pivot nut	10 N•m (1 kgf•m)	
Brake light switch screw	1 N•m (0.1 kgf•m)	
Brake caliper mounting bolt	35 N•m (3.5 kgf•m)	ALOC bolt: replace with a new one.
Brake caliper bleed screw	5.5N•m (0.55 kgf•m)	
Brake hose oil bolt	35 N•m (3.5 kgf•m)	

2.4.SPECIAL TOOLS

Lock nut wrench	A120F00002
Oil seal and bearing installer	A120E00014
Bearing piller	A120E00037
Lock nut wrench	A120F00023
Bearing race remover	A120F00009
Bearing race installer	A120F00019

2.5.TROUBLESHOOTING

Hard steering (heavy)

- Excessively tightened steering stem top cone race
- Broken steering balls
- Insufficient tire pressure

Steers to one side or does not track straight

- Uneven front shock absorbers
- Bent front fork
- Bent front axle or uneven tire

Poor brake performance

- Worn brake pads
- Contaminated brake pad surface
- Deformed brake disk
- Air in brake system
- Deteriorated brake fluid
- Worn brake master cylinder piston oil seal
- Clogged brake fluid line
- Unevenly worn brake caliper

Front wheel wobbling

- Bent rim
- Loose front axle
- Bent spoke plate
- Faulty tire
- Improperly tightened axle nut

Soft front shock absorber

- Weak shock springs
- Insufficient damper oil

Front shock absorber noise

- Slider bending
- Loose fork fasteners
- Lack of lubrication

3. Front Wheel

3.1. Removal

Lift the front end of the vehicle with a suitable stand or jack so that the front wheel comes off of the ground.

Loosen the front axle pinch bolt (2) with a 6 mm Allen.

Remove the front axle (1) with an 8 mm Allen socket.

Support the front wheel and slide the front axle out from the left side.

Guide the front wheel out from the fork legs and the brake disc out from between the pads. Do not squeeze the brake lever while the disc is not present between the pads.

Install in the reverse order of work.

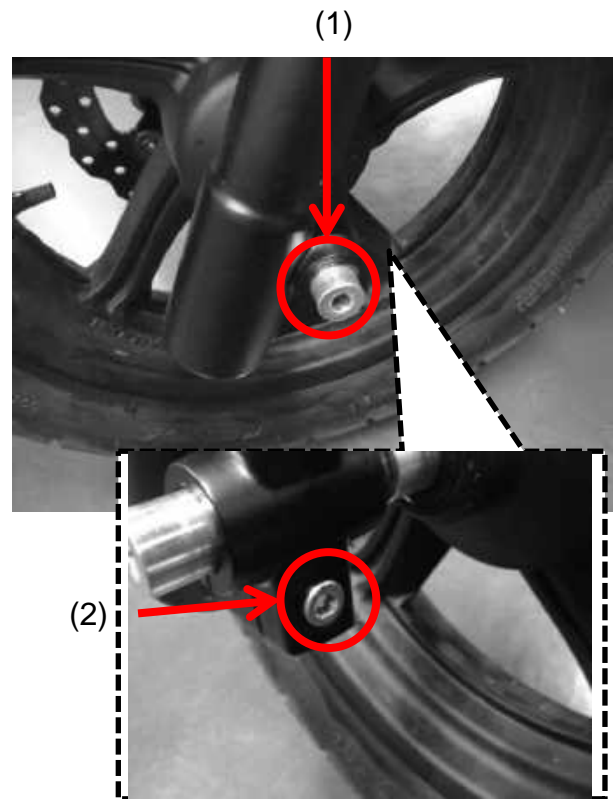

3.2. Inspection

Remove the collars from each side of the wheel. Inspect the bearing seals and the O-rings seals on the collars. Replace the seals if they are in poor condition.

Turn the inner race of each bearing with your finger to see if they turn smoothly and quietly. Also check if the outer race fits tightly in the hub. Replace the bearings if the races do not turn smoothly, quietly, or if they fit loosely in the hub.

Axle Runout

Set the axle in V blocks and measure the runout using a dial gauge.

Check the front axle runout. The axle runout specification is half of the total indicator reading.

The actual runout is 1/2 of the total indicator reading.

Service Limit: 0.2 mm (0.008 in)

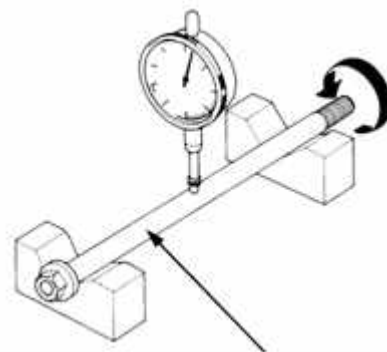

Wheel Rim

Place the wheel on a truing stand and use a dial indicator to check if the rim is out of true. The specifications for the front and rear wheels are the same. Check for lateral wobble. The service limit is 2.0 mm (0.08 in) or less.

Check for radial hop. The service limit is 2.0 mm (0.08 in) or less.

Service Limit:

Axial: 2.0 mm

Radial: 2.0 mm

Apply grease to the collar, and then install the collar onto the wheel.

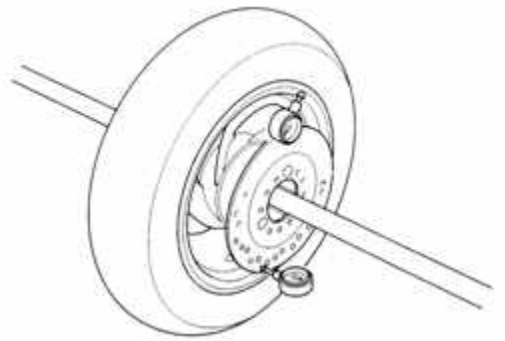

3.3. Disassembly

Replace bearings as a set, and do not reuse old bearings.

Place the new bearings in the freezer about an hour before you plan to install them.

Do not let the wheel rest on its brake disc.

Remove the side collar and dust seal.

The seal should be replaced with a new item.

Turn the inner race of each bearing with your finger to see if they turn smoothly and quietly. Also check if the outer race fits tightly in the hub.

Replace the bearings if the races do not turn smoothly, quietly, or if they fit loosely in the hub.



Remove the front wheel bearing by using the special tool.

Special tool:

Bearing puller: A120E00037

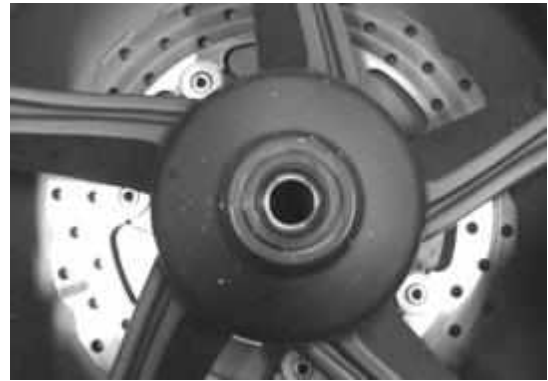

Remove the distance collar from wheel.



3.4. Assembly

Heat the bearing area of the wheel with a heat gun, take the bearing out of the freezer and install it. You can use a bearing installer tool or a socket with the same outside diameter as the bearing. Make sure the bearing is fully seated and the marked side is facing out.

Special tool:

Bearing installer A120E00014

Insert the distance collar into the hub.

Drive in the other bearing. The bearing should fit against the distance collar.

Do not continue to force the bearing in or the distance collar will begin to push the right bearing back out.

Apply grease to the lips of the dust seals. Drive in new dust seals.



4. Front Brake Fluid

4.1. Check

Brake fluid: Fluid leakage → Replace.

Brake hose: Cracks/wear/damage → Replace.

Apply the brake lever several times.

Brake hose clamp: Loosen → Tighten

4.2. Fluid Replacement/Air Bleeding

Once the hydraulic system has been opened, or if the brake feels spongy, the system must be bled. When using a commercially available brake bleeder, follow the manufacturer's operating instructions.

- ※ A contaminated brake disc or pad reduces stopping power. Discard contaminated pads and clean a contaminated disc with a high quality brake degreasing agent.
- ※ Do not allow foreign material to enter the system when filling the reservoir.
- ※ Avoid spilling brake fluid on painted, plastic or rubber parts. Place a rag over these parts whenever the system is serviced.

4.3. Brake Fluid Draining

Make sure that the master cylinder parallel to the ground, before removing the reservoir cover.

Remove the two screws.

Remove the reservoir cover, diaphragm plate and diaphragm.

Connect a bleed hose to the bleed valve



Loosen the bleed valve and pump the brake lever.

Stop operating the brake when no more fluid flows out of the bleed valve.

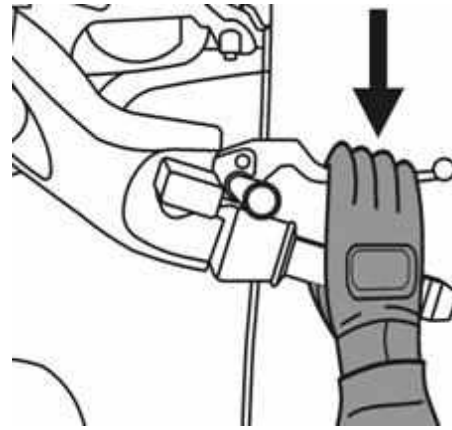

4.4. Brake Fluid Filling/Air Bleeding

※ Do not mix different types of fluid since they are not compatible.

Fill the master cylinder with DOT 4 brake fluid to the upper level.

Connect a commercially available brake bleeder to the front caliper bleed valve.

Check the fluid level often while bleeding the brake to prevent air from being pumped into the system.

When using a brake bleeding tool, follow the manufacturer's operating instructions.

※ If air enters the bleeder from around the bleed valve threads, seal the threads with teflon tape.

Pump the brake bleeder and loosen the front caliper bleed valve. Add fluid when the fluid level in the master cylinder is low to prevent drawing air into the system.

Repeat the above procedures until no air bubbles appear in the plastic hose.

Close the front caliper bleed valve and operate the front brake lever.

If it still spongy, bleed the system again.

If the brake bleeder is not available, perform the following procedure.

Pump up the system pressure with the brake lever until these are not air bubbles in the fluid flowing out of the reservoir small hole and lever resistance is felt.

1. Pump the brake lever several times, then squeeze the brake lever all the way and loosen the bleed valve 1/4 turn. Wait several seconds and close the bleed valve

※ If air enters the bleeder from around the bleed valve threads, seal the threads with teflon tape.

2. Release the brake lever slowly until the bleed valve has been closed. Add fluid when the fluid level in the master cylinder is low to prevent drawing air into the system.

3. Repeat the steps 1 - 2 until there are no air bubbles in the bleed hose.

After bleeding air completely, tighten the bleed valve to the specified torque.

Torque: 6 N•m (0.6 kgf•m, 4.3 lbf•ft)

Fill the reservoir to the casting ledge with DOT 4 brake fluid to the upper level.

Install the diaphragm, set plate and reservoir cover and tighten the screws to the specified torque.

Torque: 2 N•m (0.2 kgf•m, 1.1 lbf•ft)

5. Front Brake Pad

5.1. Brake Pad Replacement

Remove the pad pins (1).

Remove the two caliper mounting bolts (2), and then remove the caliper.

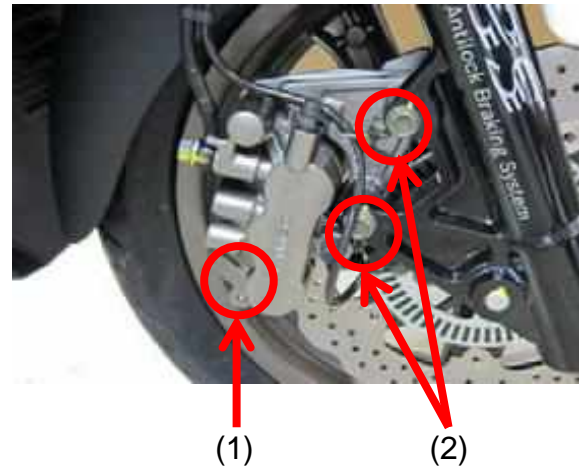

Remove the brake pads. Replace the pads if the brake wear exceeds the wear indicator lines or if the wear is uneven. Insert new brake pads as needed.

※ Always replace the brake pads in pairs to ensure even disc pressure.



Apply a light coat of waterproof grease to the brake pad pin. Push the pads against the pad spring and insert the brake pad pin. It may be necessary to spread the pads and force the pistons back into the caliper in order to allow room for the brake disc to fit between the new pads.



Install the front caliper onto the fork leg and then install and tighten the new two caliper mounting bolts to the specified torque.

Torque: 35 N-m (3.5 kgf-m)

Tighten 1 pad pins to the specified torque.

Torque: 18 N-m (1.8 kgf-m, 13 lbf-ft)

6. Brake Disc

6.1. Inspection

Visually inspect the brake disc for damage or cracks.

Measure the brake disc thickness.

Service limits: 4 mm

Replace the brake disc if the smallest measurement is less than the service limit.

Measure the brake disc warpage.

Service limits: 0.3 mm

6.2. Removal

Remove the front wheel.

Remove the five brake disc mounting bolts with an Allen wrench.

Remove the front brake disc and front wheel speed sensor rotor.

Install in the reverse order of work.

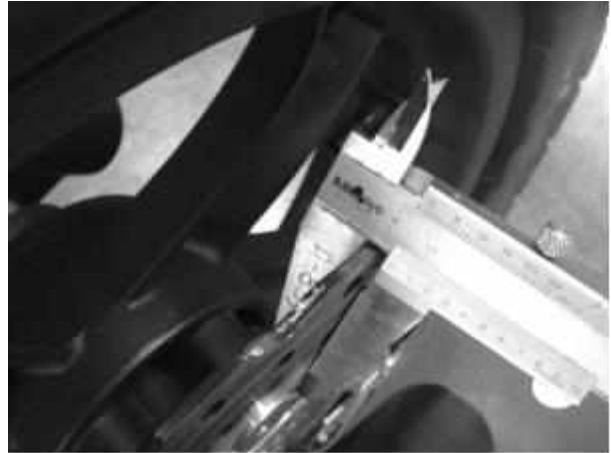

7. Handlebar

7.1. Removal

Remove the lower handlebar cover and front cover.

Remove the 4 bolts and disconnect the brake light switch wire, then remove the front and rear brake master cylinder.

Remove the inner cover

Route the cables and lines from the handlebar cable guide.

Remove the handlebar lock nut and take out the bolt.

Remove the handlebar and collar.

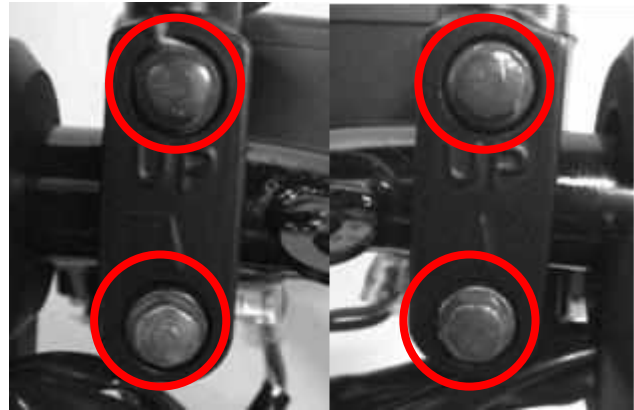

7.2. Installation

Install the handlebar onto the steering stem and install the handlebar collar, lock nut and bolt.

Tighten the bolt to the specified torque.

Torque: 4.5 kgf-m (45 N-m, 32 lbf-ft)

Install the front and rear master cylinders and connect the brake light switch wires

※ **Adjust the throttle grip free play to the specified range of 2~6 mm (0.08 ~0.24 in).**



7.3. Disassembly

Switches

Remove the two screws from right handlebar switch.

Disconnect the throttle cables and free the right switch housing from the handlebar.

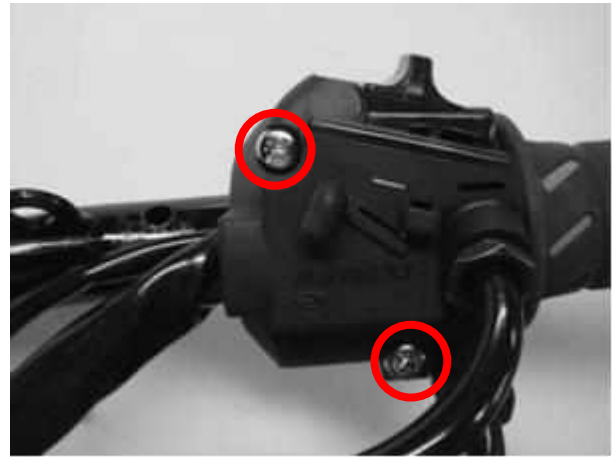

Remove the two screws and then remove the left handlebar switch.

Disconnect the switch. Separate the left switch housing from the handlebar.

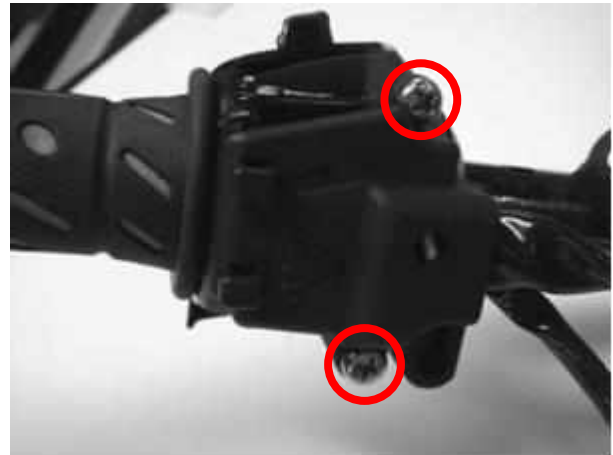

Bar ends

Remove the bar ends with a 6 mm Allen.



Grips

Remove the right handlebar switch.

Disconnect the throttle cable from the throttle grip.

Remove the throttle grip.

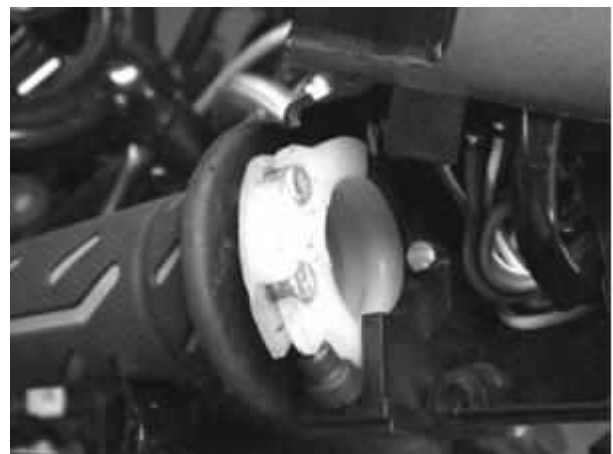

If you plan to replace the grips you can slice them lengthwise with a razor blade and peel them off. To remove the grips without cutting them use a screwdriver to open a gap between the grip and the handlebar. Spray in contact cleaner to break up the grip cement. Use compressed air to expand the grip so it can be easily slid off the end of the handlebar. Note the relationship between the angle of the grip and the throttle tube so that the new grip can be installed with the correct angle.



Before installing the grips to either the throttle tube or the handlebar, wipe down the area with a brake or parts cleaner that will dry without leaving a residue.

When you are sure the area is dry apply grip cement to the bar or tube. Install the left grip at an angle of your preference. Install the throttle grip onto the tube with the same angle as the original grip.

※ Always wear safety glasses when using compressed air and never point it directly at yourself or anyone else.

7.4. Assembly

Install the left handlebar switch.

※ Align the pin on the left handlebar switch with the hole on the handlebar.

Install and tighten the two screws securely.

Install the right handlebar switch.

※ Align the pin on the right handlebar switch with the hole on the handlebar.

Lubricate the throttle grip front end with grease and then connect the throttle cable to the throttle grip.

Install and tighten the two screws.

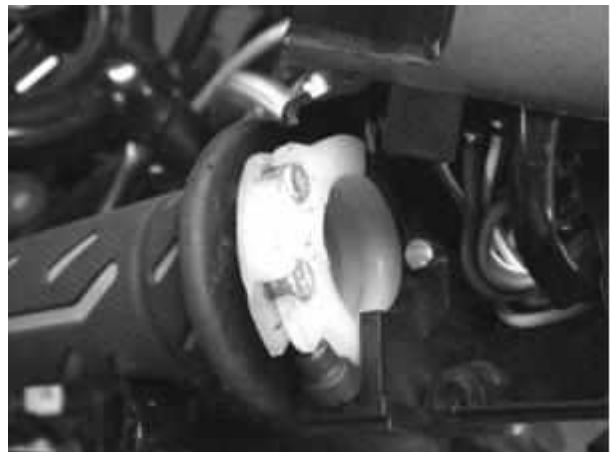

8. Front Shock Absorber

8.1. Removal

Remove the front cover and front fender.

Remove the front brake caliper.

Remove the front wheel.

Remove the speed wheel sensor bolt (1).

Remove the speed sensor wire and front brake hose guide mounting bolt with an 8 mm socket. Free the guide from the fork clamp.

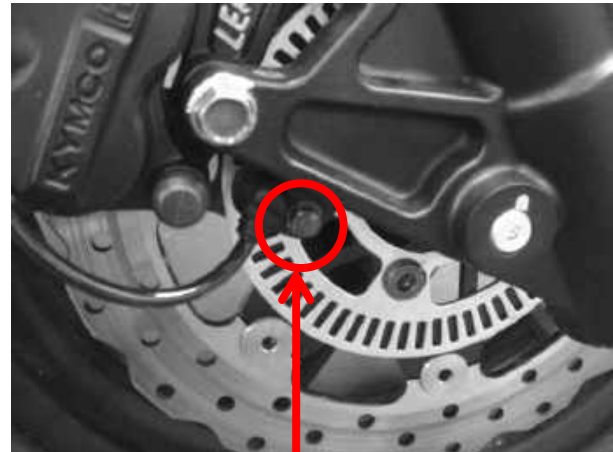

(1)

Loosen the fork clamp pinch bolts with a 12 mm socket. The top bolts must be removed.

Slide the forks legs down and out of the fork clamp using a twisting motion.

Installation is in the reverse order of removal.

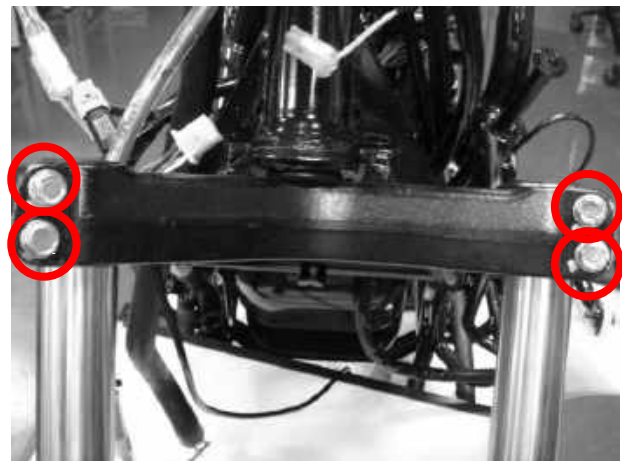

※ Tighten the shock absorber mounting bolt to the specified torque.

Torque: 3.2 kgf-m (32 N-m, 23 lbf-ft)

8.2. Inspection

Inspect the following items and replace if necessary.

- Front shock absorber tube bending, damage or wear
- Weak front shock absorber spring
- Damper and damper rod bending
- Oil seal damage or wear



9. Steering Stem

9.1. Removal

Support the vehicle with a suitable stand or jack so that the front wheel is off the ground. Grip the bottom of the fork legs and turn the front end side-to-side. If the movement is rough the bearings should be greased or replaced. If the movement is too tight or loose the steering stem adjusting nut may need to be adjusted.

Always replace the races at the same time as the bearings.

Remove the handlebar covers.

Remove the front cover.

Remove the handlebar.

Remove the front fender.

Remove the front wheel.

Remove the front fork.

Hold the steering stem top cone race and remove the steering stem lock nut by using the special tool.

Special tool:

Lock nut wrench **A120F00002**

Remove the top cone race and washer remove the steering stem.

※ **Be careful not to lose the steel balls (26 on top race and 19 on bottom race).**

Lock nut wrench: **A120F00023**





Inspect the ball races, cone races and steel balls for wear or damage. Replace if necessary.

Remove the top balls.



Remove the bottom balls.



Use the special tools or a drift and hammer to drive out the bearing races in the steering head.

Have the drift set against the lip of the race, and work around the race evenly to drive it out. Repeat the process with the remaining bearing race.

Use a chisel to remove the bottom bearing inner race and dust seal.



Bottom Cone Race

※ Be careful not to damage the steering stem.



9.2. Installation

Install the new bottom cone race onto the steering stem.

Install the new upper and bottom ball races into the frame.

Apply grease to the top and bottom ball races and install new steel balls on the top ball race and new steel balls on the bottom ball race.

Install the steering stem.

Apply grease to the top cone race and install it.

Tighten the top cone race and then turn the steering stem right and left several times to make steel balls contact each other closely.

※ **Check that the steering stem rotates freely without vertical play.**

Special tool:

Lock nut wrench: A120F00023

Install the steering stem lock nut and tighten it to the specified torque by using the special tool while holding the top cone race.

Torque: 7 kgf-m (70 N-m)

Special tool:

Lock nut wrench A120F00002



Bottom Ball Race
Remove Special Tool



A120 F00009

Bottom Ball Race
Install special tool

Top Ball Cone Race
Install special tool

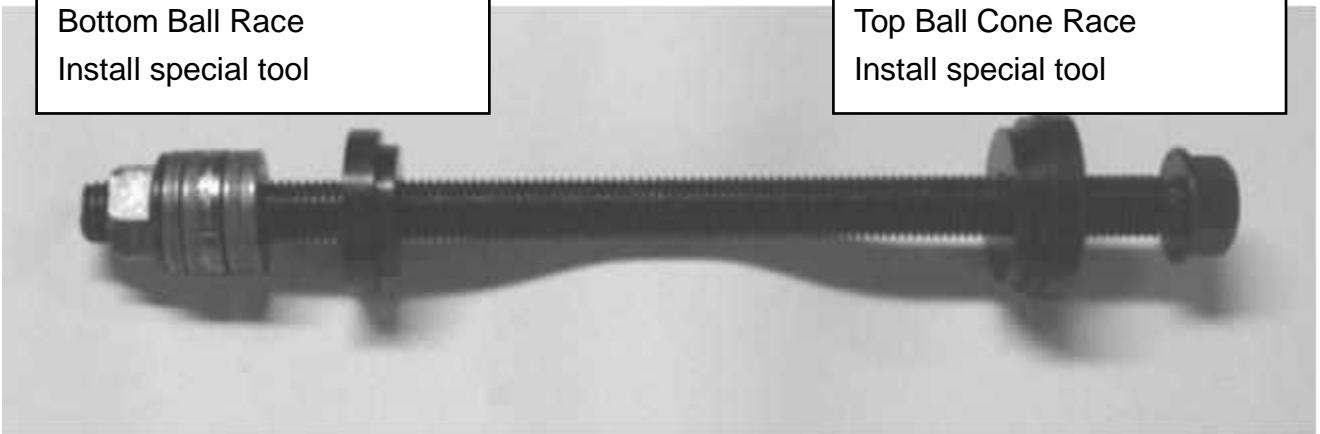

A120 F00019

Rear Assembly

1.	SCHEMATIC DRAWING	2
2.	SERVICE INFORMATION.....	3
2.1.	General Instructions.....	3
2.2.	Specifications	3
2.3.	Torque Values	3
2.4.	Troubleshooting	4
3.	Rear Brake	5
3.1.	Rear Brake Caliper Removal	5
3.2.	Inspection	5
3.3.	Disassembly	6
3.4.	Assembly	7
3.5.	Installation	8
4.	Rear Fork	9
4.1.	Removal	9
4.2.	Inspection	9
5.	Rear Wheel	10
5.1.	Removal	10
5.2.	Inspection	10
5.3.	Installation	10
6.	Rear Shock Absorber	11
6.1.	Removal	11
6.2.	Installation	11

1. SCHEMATIC DRAWING

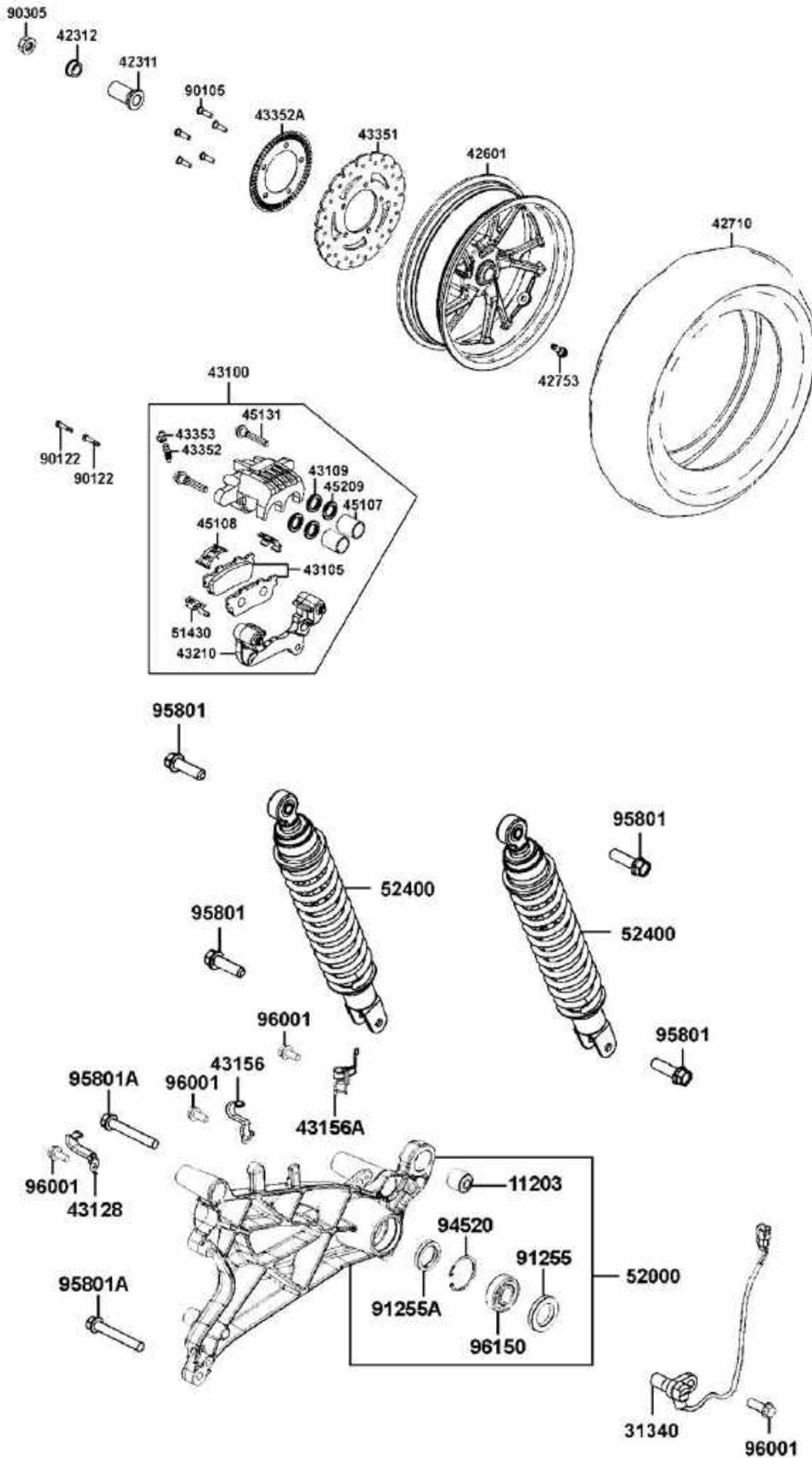

2. SERVICE INFORMATION

2.1. General Instructions

- When performing the services stated in this section, the engine and exhaust muffler must be cold to avoid scalding.
- During servicing, keep oil or grease off the brake pads and brake disk.

2.2. Specifications

Item	Standard (mm)	Service Limit (mm)
Rear wheel rim runout	---	2.0
Rear brake disk thickness	5.0	4.0
Rear brake disk runout	---	0.3
Rear brake master cylinder I.D.	27.00	
Rear brake master cylinder piston O.D.	26.95	

2.3. Torque Values

Item	Value	
	N-m	kgf•m
Exhaust muffler lock bolt	45 N-m	4.5 kgf•m
Exhaust muffler pipe nut	20 N-m	2 kgf•m
Rear axle nut	120 N-m	12 kgf•m
Rear shock absorber lower mount bolt	40N-m	4 kgf•m
Rear shock absorber upper mount bolt	40N-m	4 kgf•m
Rear brake caliper holder bolt	35 N-m	3.5 kgf•m

2.4. Troubleshooting

Rear wheel wobbling

- Bent rim
- Faulty tire
- Axle not tightened properly
- Engine not tightened properly
- Tire pressure too low
- Unbalanced wheel

Soft suspension

- Weak shock absorber spring
- Damper oil leaks

Hard suspension

- Incorrectly mounted suspension components
- Incorrect damper adjustment
- Bent swing arm pivot
- Bent damper rod
- Damaged swing arm pivot bearing(s)
- Faulty suspension linkage
- Damaged linkage pivot bearings

Rear wheel noise

- Worn rear wheel axle bearings
- Worn rear fork bearings
- Deformed rear fork

Poor brake performance

- Air in brake system
- Deteriorated brake fluid
- Contaminated brake pad surface
- Worn brake pads
- Clogged brake fluid line
- Deformed brake disk
- Unequal worn brake caliper

3. Rear Brake

3.1. Rear Brake Caliper Removal

Drain the rear brake fluid.

Place a suitable container under the banjo bolt to catch any remaining brake fluid.

Remove the banjo bolt that holds the brake hose.

Discard the two sealing washers.

Replace the brake hose banjo bolt sealing washers with new items on assembly.

Remove the exhaust muffler.

Remove the rear brake fluid tube bolt and disconnect the brake fluid tube.

Remove two bolts attaching the rear brake caliper.

Remove the rear brake caliper.

※ **When removing the brake fluid tube, use shop towels to cover plastic parts and coated surfaces to avoid damage.**

3.2. Inspection

Inspect the brake pads and brake disk.

Measure the brake disk thickness.

Visually check the brake pad thickness



Fluid Tube Bolt

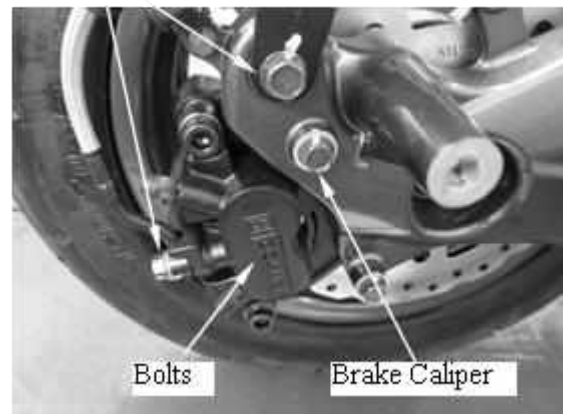

3.3. Disassembly

Remove two brake pads dowel pins and three bolts from the brake caliper.

Remove the brake pads.

Remove the piston from the brake caliper.

If necessary, use compressed air to squeeze out the piston through the brake fluid inlet opening and place a towel under the caliper to avoid contamination caused by the removed piston.

Check the piston cylinder for scratches or wear and replace if necessary.

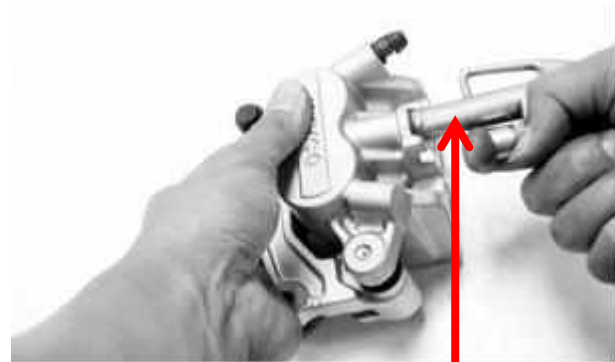

Compressed Air

Push the piston oil seal outward to remove it.

Clean the oil seal groove with brake fluid.

※ **Be careful not to damage the piston surface.**



Check the piston for scratches or wear.

Measure the piston O.D. with a micrometer gauge.



Check the caliper cylinder for scratches or wear and measure the cylinder bore.



3.4. Assembly

Clean all removed parts.

Apply silicon grease to the piston and oil seal. Lubricate the brake caliper cylinder inside wall with brake fluid.

Install the brake caliper piston with grooved side facing out.

※ Install the piston with its outer end protruding 3 ~ 5mm beyond the brake caliper.

Install the two spring plates onto the groove of the caliper.

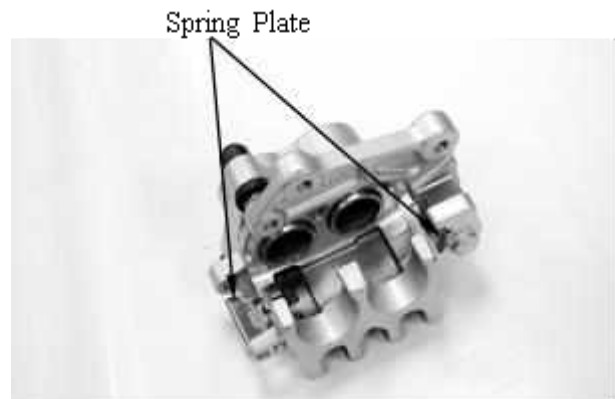

※ Make sure the spring plate next to the brake pad dowel pin orientation.

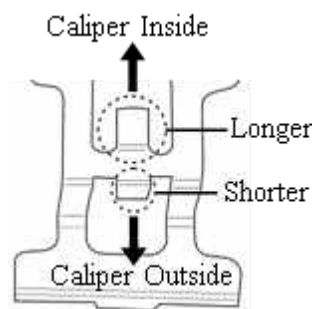

Install two brake pads and brake pad dowel pin.

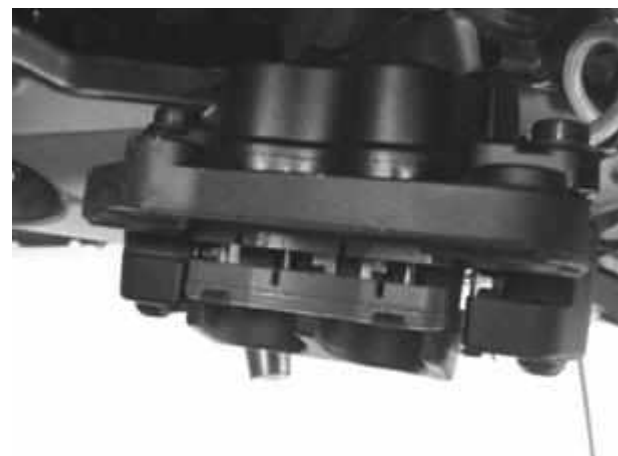

3.5. Installation

Install the brake caliper to the rear fork and tighten the two bolts.

Torque: 35 N-m

Connect the brake fluid tube to the brake caliper and install fluid tube bolt, copper washers and tighten the fluid tube bolt.

Fill the brake reservoir with the specified brake fluid and bleed air from the brake system.

※ **When installing the brake fluid tube, be sure to install the two copper sealing washers.**

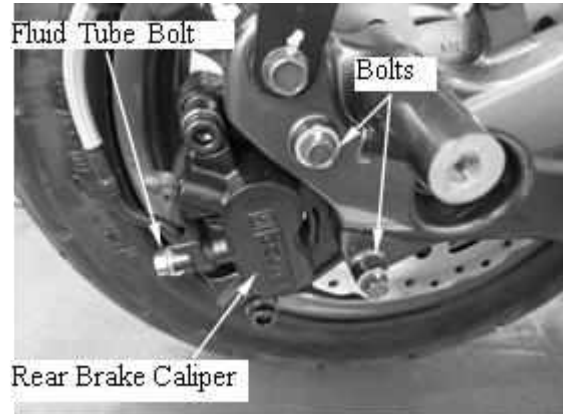

4. Rear Fork

4.1. Removal

Place the vehicle on its center stand.

Remove the exhaust muffler.

Remove the rear brake caliper.

Remove the speed sensor.

Remove the speed sensor wire and the rear brake fluid hose holder.

Remove the lower mounting bolt of the right side rear shock absorber.

Remove the rear axle nut and collar.

Remove the rear fork mounting bolts.

Remove the rear fork.

※ **Wrap the rear caliper with a proper cloth to protect the rear fork and covers from being scratched.**

Install in the reverse order of work.

4.2. Inspection

Remove the clip.

Turn the inner race of each bearing with your finger to see if they turn smoothly and quietly. Also check if the outer race fits tightly in the hub.

Replace the bearings if the races do not turn smoothly, quietly, or if they fit loosely in the hub.

Inspect the dust seal for damage or worn.

Replace it if necessary.

Apply grease on the dust seal before install.

Inspect the rubber bush for damage or worn.

Replace it if necessary.

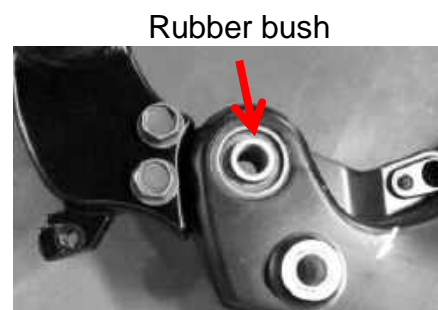
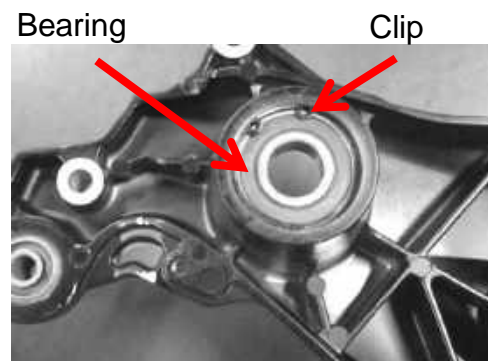
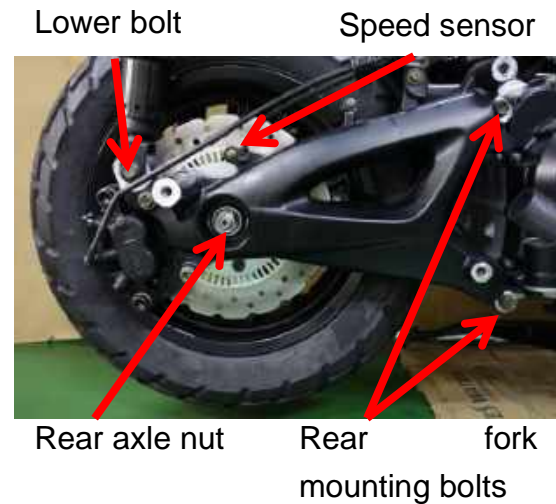

5. Rear Wheel

5.1. Removal

- Remove the exhaust muffler.
- Remove the rear brake caliper.
- Remove the rear fork.
- Remove the rear axle collar.
- Remove the rear wheel.

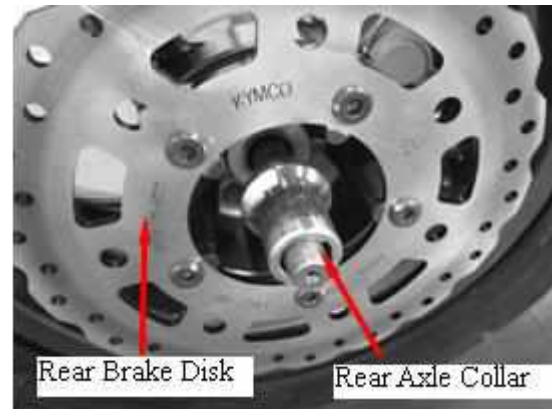

5.2. Inspection

- Measure the rear wheel rim runout.

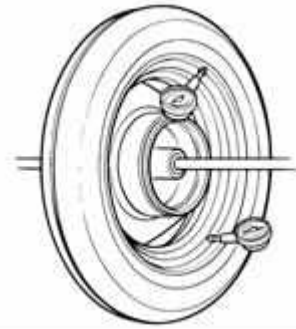

5.3. Installation

- Apply a proper amount of grease on the rear axle before installation.
- Install in the reverse order of work.

Torque:

Rear shock absorber lower mount bolt:
35~45N-m

Rear axle nut: 120 N-m



6. Rear Shock Absorber

6.1. Removal

Remove the met-in box and carrier.

Remove the body cover, center cover and rear fender together.

Remove the right/left rear shock absorber upper and lower mount bolts.

Remove the right and left rear shock absorbers.

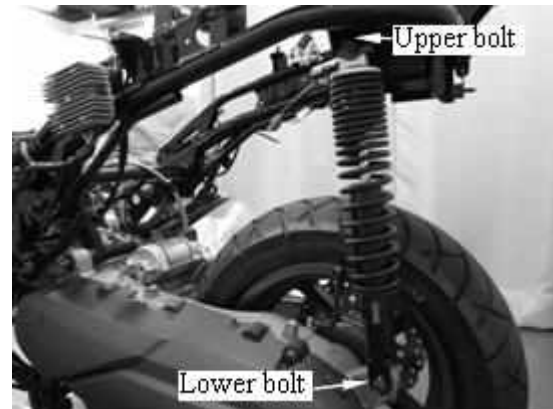

6.2. Installation

Install the rear shock absorbers in the reverse order of removal.

Torque:

Upper Mount Bolt: 40 N-m

Lower Mount Bolt: 40 N-m

Battery/Charging System

- 1. CHARGING SYSTEM LAYOUT..... 2
- 2. SERVICE INFORMATION..... 3
 - 2.1. GENERAL INSTRUCTIONS 3
 - 2.2. SPECIFICATIONS..... 4
 - 2.3. TROUBLESHOOTING 4
- 3. Battery..... 5
 - 3.1. Removal..... 5
 - 3.2. Installation..... 5
 - 3.3. Voltage Inspection..... 5
 - 3.4. Battery Charging..... 6
- 4. Charging System Inspection 7
 - 4.1. Charging Voltage 7
- 5. Regulator/Rectifier 8
 - 5.1. Inspection..... 8
 - 5.2. Removal/Installation 9

1. CHARGING SYSTEM LAYOUT

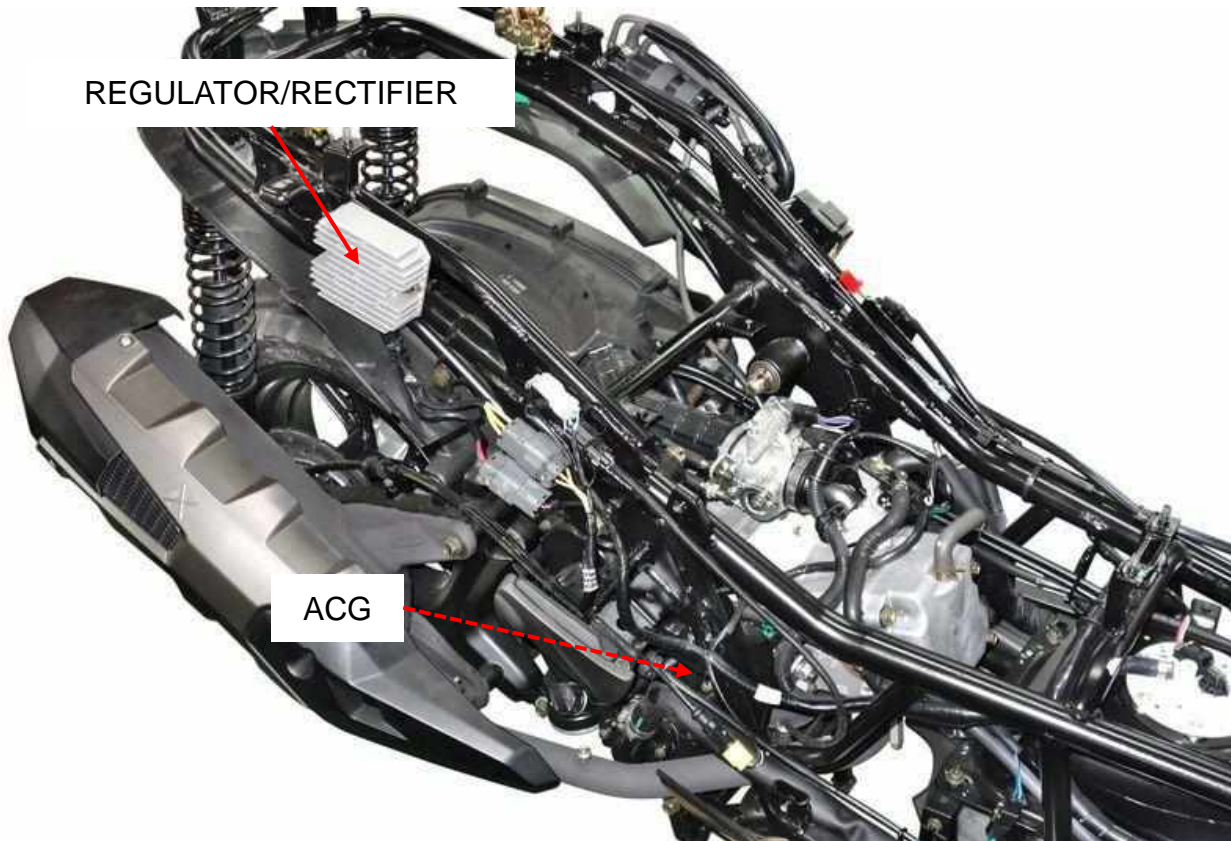
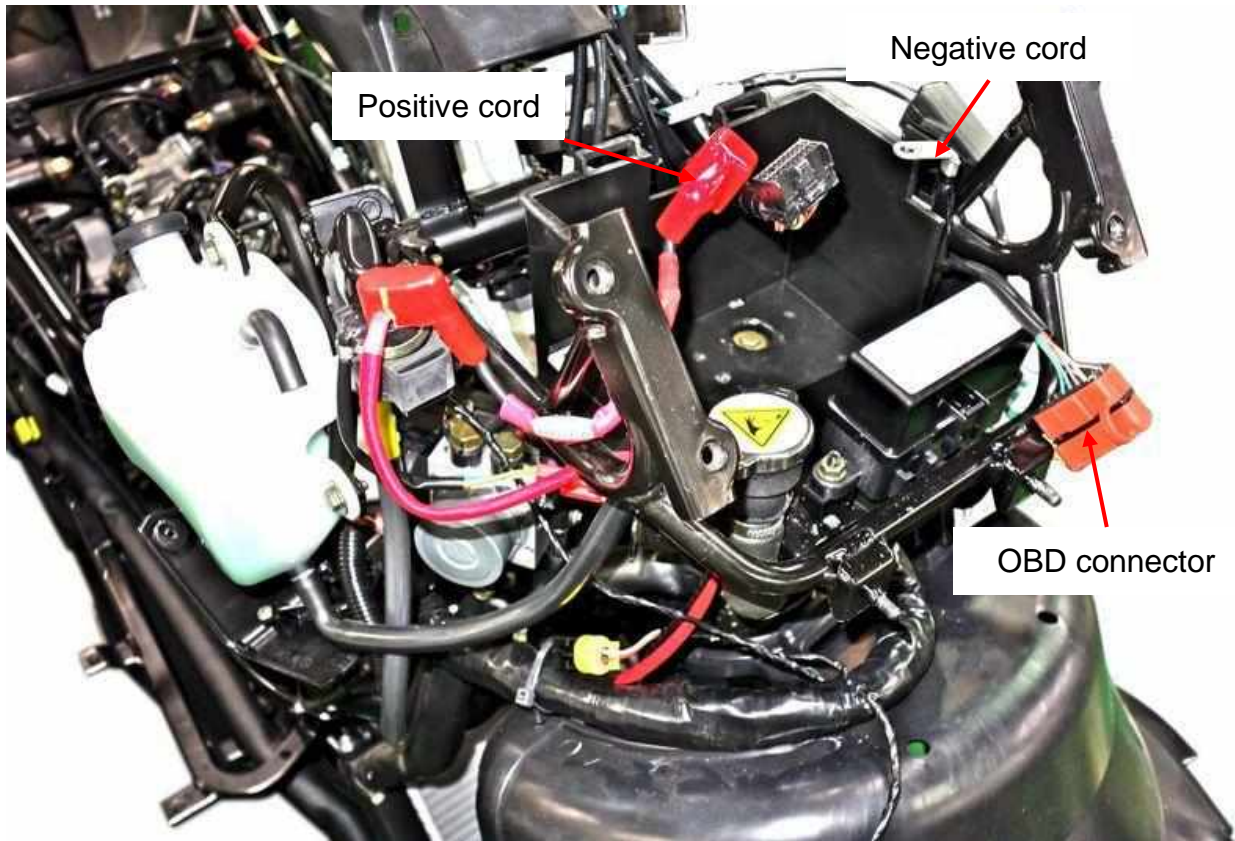

2. SERVICE INFORMATION

2.1. GENERAL INSTRUCTIONS

- The battery can be charged and discharged repeatedly. If a discharged battery is not used for a long time, its service life will be shortened. Generally, the capacity of a battery will decrease after it is used for 2~3 years. A capacity-decreased battery will resume its voltage after it is recharged but its voltage decreases suddenly and then increases when a load is added.
 - When a battery is overcharged, some symptoms can be found. If there is a short circuit inside the battery, no voltage is produced on the battery terminals. If the rectifier won't operate, the voltage will become too high and shorten the battery service life.
 - If a battery is not used for a long time, it will discharge by itself and should be recharged every 3 months.
 - A new battery filled with electrolyte will generate voltage within a certain time and it should be recharged when the capacity is insufficient. Recharging a new battery will prolong its service life.
 - Inspect the charging system according to the sequence specified in the Troubleshooting.
 - Do not disconnect and soon reconnect the power of any electrical equipment because the electronic parts in the regulator/rectifier will be damaged. Turn off the ignition switch before operation.
 - It is not necessary to check the MF battery electrolyte or fill with distilled water.
 - Check the load of the whole charging system.
 - Do not quick charge the battery. Quick charging should only be done in an emergency.
 - Remove the battery from the motorcycle for charging.
 - When replacing the battery, do not use a traditional battery.
 - When charging, check the voltage with an electric tester.
- ※ **The battery electrolyte (sulfuric acid) is poisonous and may seriously damage the skin and eyes. Avoid contact with skin, eyes, or clothing. In case of contact, flush with water and get prompt medical attention**

2.2. SPECIFICATIONS

Item		Standard
Battery	Capacity	
	Voltage (20°C)	Fully charged
		Undercharged
	Charging current	Normal
Quick		
Alternator	Capacity	
	Charging coil resistance (20°C)	
	RPM of charging start	
	Charging performance	
Regulator/ Rectifier	Regulated voltage	

2.3. TROUBLESHOOTING

No power

- Dead battery
- Disconnected battery cable
- Fuse burned out
- Faulty ignition switch

Low power

- Weak battery
- Loose battery connection
- Charging system failure
- Faulty regulator/rectifier

Intermittent power

- Loose battery cable connection
- Loose charging system connection
- Loose connection or short circuit in ignition system

Charging system failure

- Loose, broken or shorted wire or connector
- Faulty regulator/rectifier
- Faulty A.C. generator

3. Battery

3.1. Removal

The battery is in the front part of the vehicle.

1. Remove the wind screen and front cover.
2. Remove the screws.
3. Remove the battery cover.
4. Disconnect the negative cable from the battery first, and then disconnect the positive cable.
5. Remove the battery from the battery box.

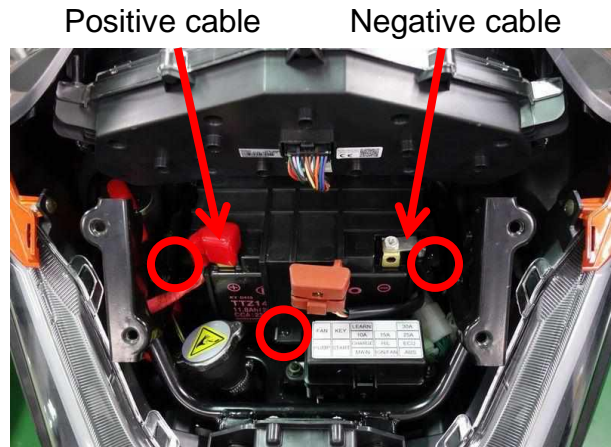

3.2. Installation

Install in the reverse order of the removal.

※ When install the battery, first connect the positive cable and then negative cable to avoid short circuit.

3.3. Voltage Inspection

Measure the battery voltage using a commercially available digital multimeter.

Voltage :

Fully charged: 13—13.2 V

Under charged: below 12.3 V

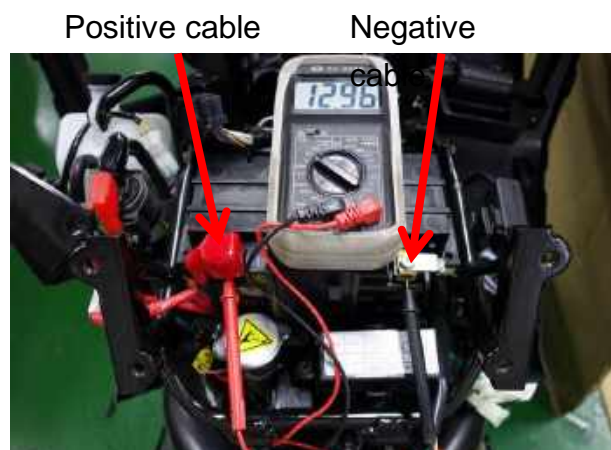

3.4. Battery Charging

Remove the battery

Connect the charger positive (+) cable to the battery positive (+) terminal.

Connect the charger negative (-) cable to the battery negative (-) terminal.

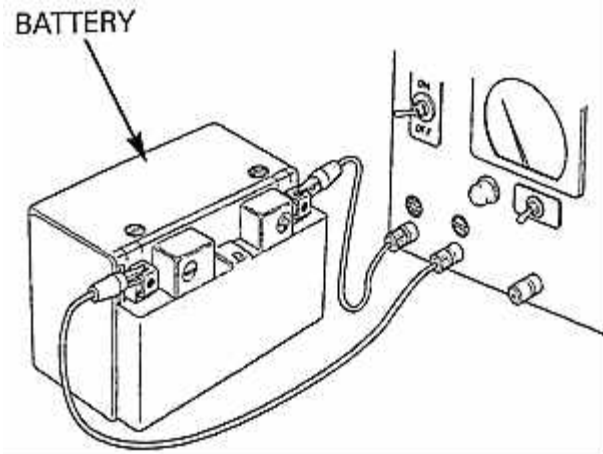

- ※ **Clean the battery terminals and position the battery as far as away from the charger as the leads will permit.**
- ※ **Always keep flammable material or spark from battery.**
- ※ **Turn off the charger after charging**
- ※ **Charging the battery under 45°C.**
- ※ **Quick charging should only be done in an emergency; slow charging is preferred.**
- ※ **For battery charging, do not exceed the charging current and time specified on the battery. Using excessive current or extending the charging time may damage the battery.**
- ※ **Measure the battery voltage after charging 30 minutes.**

Charging current time:

Standard: 1.0A/ 5~10 hours

Quick: 10 A/ 0.5 hours

4. Charging System Inspection

4.1. Charging Voltage

※ Perform this inspection after the battery is fully charged.

Start the engine and warm it up to the operating temperature; stop the engine.

Connect the multimeter between the positive and negative terminals of the battery.

To prevent short, make absolutely certain which are the positive and negative terminals or cable.

With the headlight on and turned to the high beam position, restart the engine.

Measure the voltage on the multimeter when the engine runs at 5000 min (rpm).

Standard:

14~15V/ Under 0.5A (Under 5000rpm)

Inspect the rectifier/regulator if the voltage is not in the standard.

※ Do not disconnect the battery or any cable in the charging system without first switching off the ignition switch. Failure to follow this precaution can damage the tester or electrical components.

Positive terminal Negative terminal



5. Regulator/Rectifier

5.1. Inspection

Disconnect the regulator/rectifier connectors.

Check the connectors for loose contacts of corroded terminals.

Battery line

Measure the voltage between the Red/White wire terminal and ground.

There should be battery voltage at all times.



Ground line

Check the continuity between the Green wire terminal and ground.

There should be continuity at all times and the value should be very small.

※ The inspection value should be minus the resistance value between the probes.



Check the continuity between the each yellow wire and ground wire.

There should not be continuity all times.

If there is continuity, the coil is short.

Charging coil line

Measure the resistance between each Yellow wire terminals.

Standard: 0.4 – 0.6 Ω (20°C/68°F)

Disconnect the regulator/rectifier connector. Check for continuity between each Yellow wire terminal regulator/rectifier side and ground.

There should be no continuity.



5.2. Removal/Installation

Remove the side body cover

Disconnect the regulator/rectifier connectors.

Remove the two bolts, regulator/rectifier.

Installation is in the reverse order of removal.

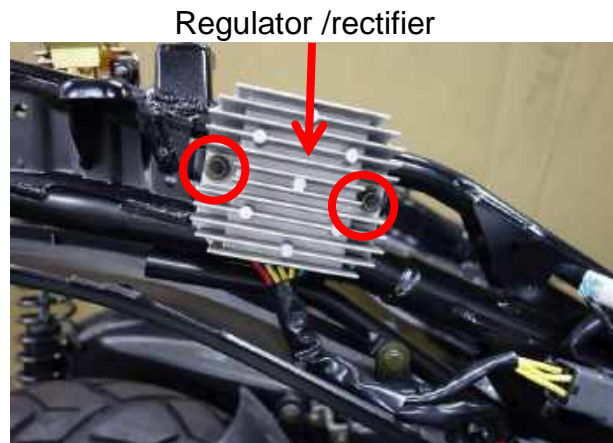

Starting System

- 1. Starting System Layout2
- 2. Service Information3
 - 2.1. General Instructions.....3
 - 2.2. Torque Values3
 - 2.3. Troubleshooting3
- 3. Start Motor4
 - 3.1. Inspection4
 - 3.2. Removal4
 - 3.3. Installation4
- 4. Starter Relay5
 - 4.1. Removal5
 - 4.2. Installation5
 - 4.3. Inspection5

1. Starting System Layout

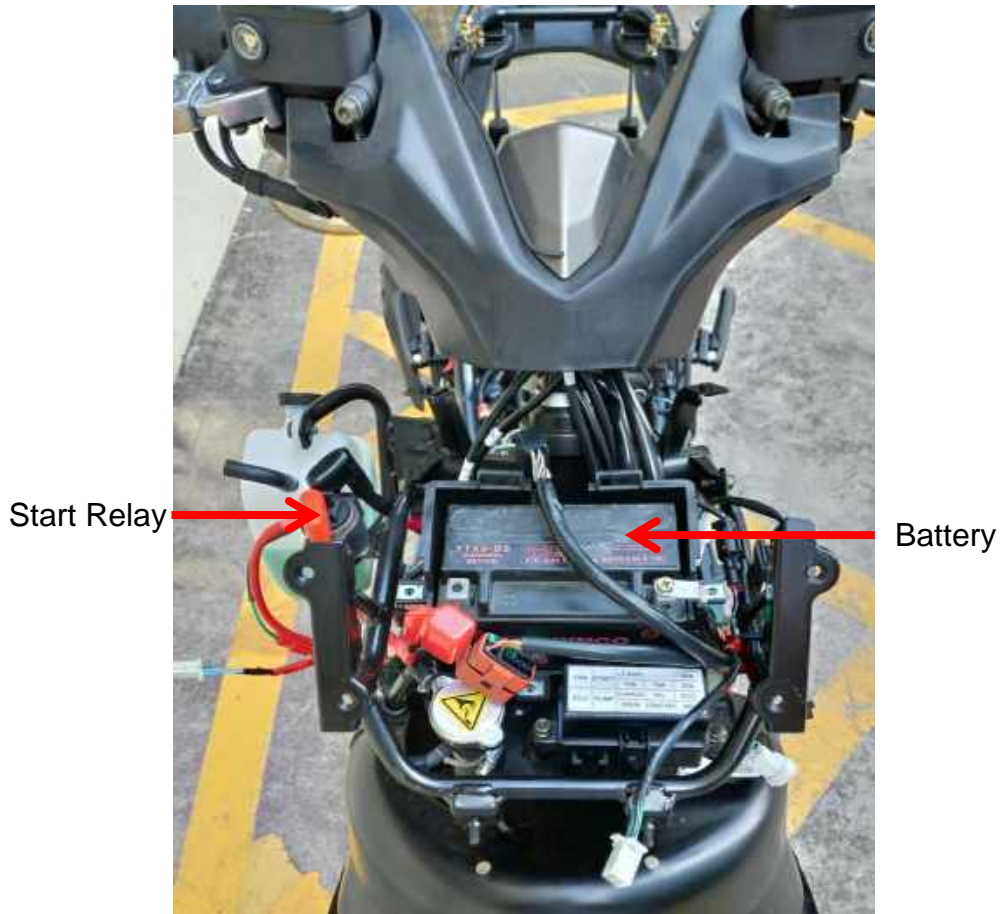

2. Service Information

2.1. General Instructions

- The removal of starter motor can be accomplished with the engine installed.
- For the starter clutch removal, refer to the chapter 10.
- After the starter clutch is installed, be sure to add the engine oil and coolant and then bleed air from the cooling system.

2.2. Torque Values

Item	Unit	
	kgf-m	N-m
Starter motor mounting bolt	0.7~1.1	7~11
ACG flywheel mounting bolt	5.0~6.0	50~60

2.3. Troubleshooting

Starter motor won't turn

- Fuse burned out
- Weak battery
- Faulty ignition switch
- Faulty starter clutch
- Faulty front or rear stop switch
- Faulty starter relay
- Poorly connected, broken or shorted wire
- Faulty starter motor

Lack of power

- Weak battery
- Loose wire or connection
- Foreign matter stuck in starter motor or gear

Starter motor rotates but engine does not start

- Faulty starter pinion
- Starter motor rotates reversely
- Weak battery

3. Start Motor

3.1. Inspection

Connect the start motor cable directly to the battery positive terminal.

If the start motor does not turn, the starter motor is faulty.

3.2. Removal

Turn the ignition switch turned to “OFF”

Release the rubber cap and remove the terminal screw to disconnect the cable from the start motor.

Remove the two mounting bolts then remove the start motor.

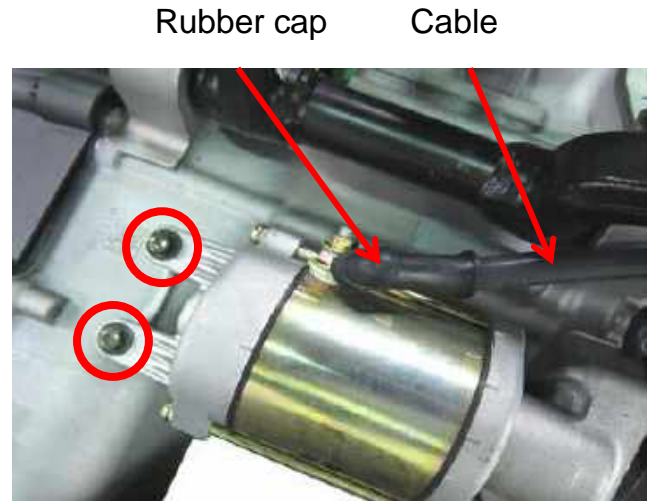

3.3. Installation

Coat a new O-ring with engine oil and install it into the start motor groove.

Install the starter motor into the crankcase.

Install the two mounting bolts securely.

TORQUE: 0.7~1.1 kgf-m

Connect the cable to motor terminal with the terminal screw and tighten it securely.

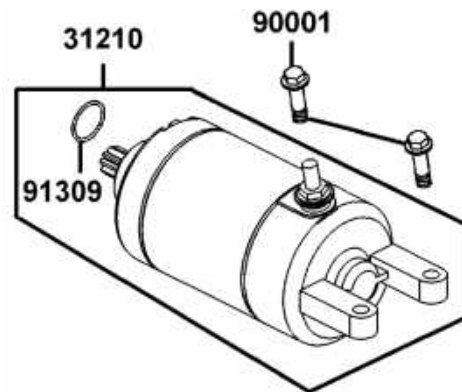

4. Starter Relay

4.1. Removal

Disconnect the starter relay wire connector.
Release the rubber caps and remove the nuts, then disconnect the start motor cable, battery positive cable and harness wire.
Remove the starter relay.



4.2. Installation

Install the starter relay.
Connect the connector and cables.
Tighten the nuts to the specified torque.

TORQUE: 0.3 kgf-m

※ If the nuts are not tightened with the specified torque, the starter relay may be damaged and fail starting.

4.3. Inspection

Continuity Test

Disconnect the starter relay wire connector.
Check for continuity between the yellow/red wire and green/yellow wire. There should be continuity when the starter button is depressed. If there is no continuity, check the starter button for continuity and inspect the wire.



Connector

Operation Test (On Board)

Turn on the ignition switch.
Squeeze the brake lever and press the start button at the same time.
The engine should be started and the starter relay will emit a click sound.

No click sound:

- Check the starter relay voltage
- Check the grounding circuit
- Check the starter relay operation

Starter Relay Voltage

Turn on the ignition switch.

Use a multimeter to measure the voltage.

One probe touch the Y/R wire the other touch the ground.

The measurement result will be close to the battery voltage

Grounding Circuit

Disconnect the connector.

Check the continuity between the green wire and the frame.

There should be continuity always.

Operation Test (Removed)

Connect the electric meter to the starter relay terminals that connect to the battery positive cable and the starter motor cable.

Connect a fully charged battery across the starter relay yellow/red and green/yellow wire terminals.

Check for continuity between the starter relay large terminals.

The relay is normal if there is continuity and it emits click sound.

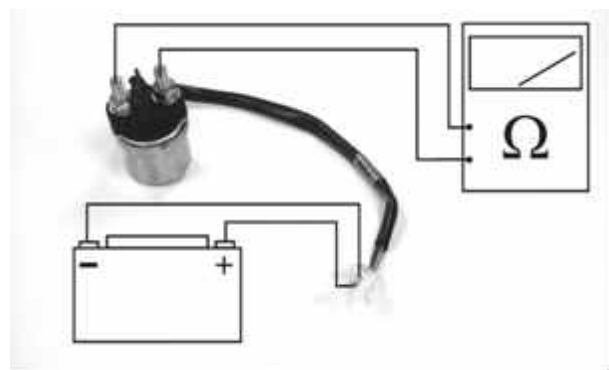

※ Do not apply the battery voltage jump for more than five seconds or the relay may be damaged.

Electrical System

1.	SERVICE INFORMATION	3
1.1.	GENERAL INSTRUCTIONS	3
1.2.	Specification	3
1.3.	Troubleshooting	3
2.	Front Lights assy	4
2.1.	Headlight	4
2.2.	Front turn signal lights.....	4
3.	Rear Lights assy.....	5
3.1.	Tail light assy	5
3.2.	License Plate Light	6
4.	Speed Sensors.....	6
4.1.	Front Speed Sensor.....	6
4.2.	Inspection	7
5.	Switches.....	8
5.1.	Brake Light Switch	8
5.2.	Ignition Switch	8
5.3.	Right handlebar switch.....	9
5.4.	Left Handlebar Switch.....	10
6.	Luggage Box Light Sensor	11
6.1.	INSPECTION.....	11
7.	Oil pressure sensor	12
7.1.	Inspection	12
7.2.	Removal	13
7.3.	Installation	13
8.	Fuel Pump.....	14
8.1.	Removal	14
8.2.	Inspection	15
8.3.	Installation	16
9.	Side Stand Switch	17
9.1.	Inspection	17
9.2.	Removal	17
9.3.	Installation	17
10.	Horn	18

10.1.	Inspection.....	18
10.2.	Removal/Installation.....	18
11.	Rollover sensor	19
11.1.	Inspection.....	19
11.2.	Removal/Installation.....	19

1. SERVICE INFORMATION

1.1. GENERAL INSTRUCTIONS

- Note the following when replacing the halogen headlight bulb
 - Wear clean gloves while replacing the bulb. Do not put finger prints on the headlight bulb, as they may create hot spots on the bulb and cause it to fail.
 - If you touch the bulb with your bare hands, clean it with a cloth moistened with alcohol to prevent its early failure.
 - Be sure to install the dust cover after replacing the bulb.
- Check the battery condition before performing any inspection that requires proper battery voltage.
- A continuity test can be made with the switches installed on the scooter.
- Route the wires and cables properly after servicing each component.

1.2. Specification

Head light	LED
Turn signal light	LED
Plate light	12V 5W
Tail/Brake light	LED
Luggage box light	LED
Meter indicator	LED
Fuses	5A, 10A, 25A, 30A

1.3. Troubleshooting

Lights do not come up, or horn does not sound after turn on the ignition switch

2. Front Lights assy

2.1. Headlight

※ Place a cloth under the headlight assy after removal to prevent scratches.

Remove the headlight assy.

Remove screws.

Remove the headlight.

Install in the reverse order of work.

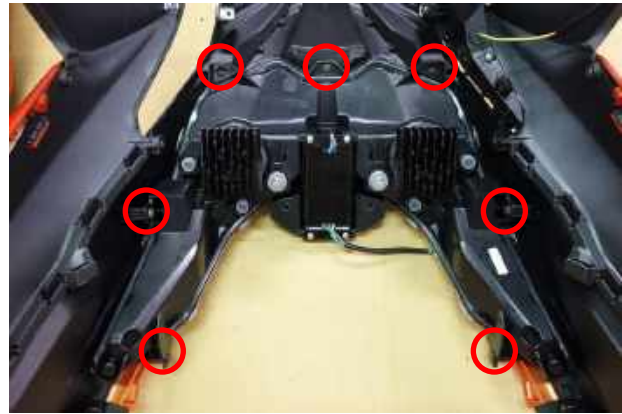

2.2. Front turn signal lights

Remove the headlight assy.

Remove the screws.

Remove the front turn signal lights.

Repeat the process on the other side.

Install in the reverse order of work.



3. Rear Lights assy

3.1. Tail light assy

Remove the rear light assy.

Remove screws on the each side of cover.

Remove the side covers.



Remove the rear center cover.

Remove the screws.



Remove the tail light assy.

Installation is in the reverse order of removal.



3.2. License Plate Light

Remove the rear light assy.
 Remove the screws.
 Remove the license plate light.



Remove the screws.

Push and turn the bulb counterclockwise to remove it, and then replace with a new one.

Specification: 12V 5W

Installation is in the reverse order of removal.



4. Speed Sensors

4.1. Front Speed Sensor

Remove the front cover.
 Disconnect the speed sensor connector.

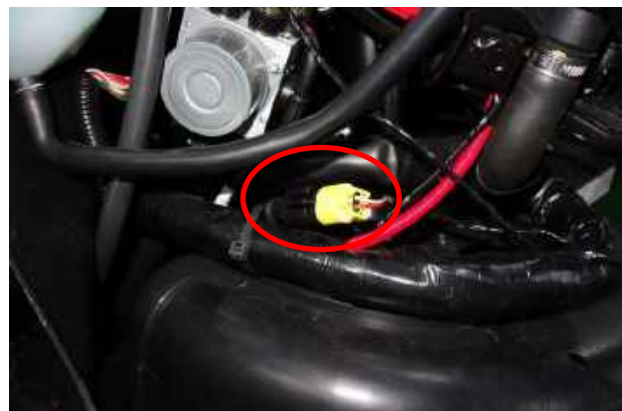

Remove the bolt.
 Remove the speed sensor.

Install in the reverse order of removal.



Rear Speed Sensor

Remove the right side cover,
Disconnect the speed sensor connector.



Remove the bolt.
Remove the rear speed sensor.

Install in the reverse order of removal.



4.2. Inspection

After remove the speed sensor, rotate the wheel to check the speed sensor ring.
If the speed sensor ring is deformed or damaged, it should be replaced.

Check the gap between the speed sensor and the ring.

Standard: 0.4~1.2mm

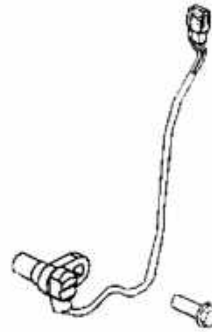

Speed sensor

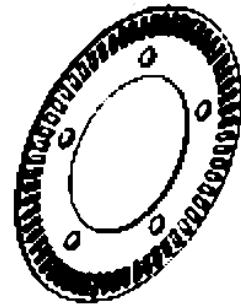

Speed sensor ring

5. Switches

5.1. Brake Light Switch

Remove the upper handlebar cover.

Disconnect front or rear light switch connectors and check for continuity between the switch terminals (1).

There should be continuity with the front or rear brake lever squeezed, and there should be no continuity when the front or rear brake lever (2) is released.

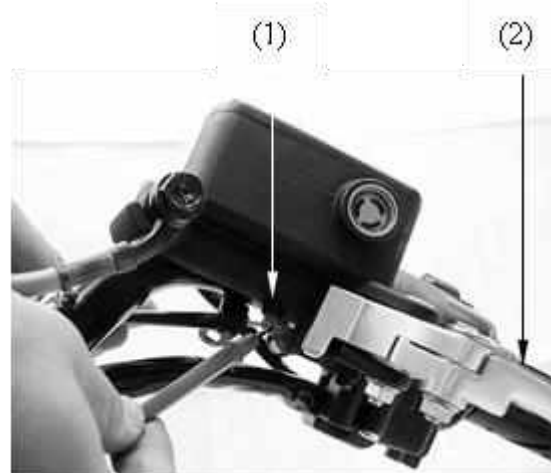

5.2. Ignition Switch INSPECTION

Remove the front cover.

Remove the leg shield.

Continuity should exist between the color code wires as follows:



CIRCUIT

		BAT1	BAT2	BAT3	KEY INSTALL AND REMOVE
OPEN	CAP OPEN	○	○		NO AUTO REVERSE
OFF	20°	○	○		NO
ON		○	○	○	NO
OPEN	PUSH SEAT OPEN	○	○	○	NO AUTO REVERSE
OFF	45°				NO
OPEN	SEAT OPEN				NO AUTO REVERSE
LOCK	PUSH				NO
OPEN	SEAT OPEN				NO AUTO REVERSE

5.3. Right handlebar switch

Disconnect the right handlebar switch connector and check for continuity at switch side connector terminals.

Continuity should exist between the color code wires as follows:

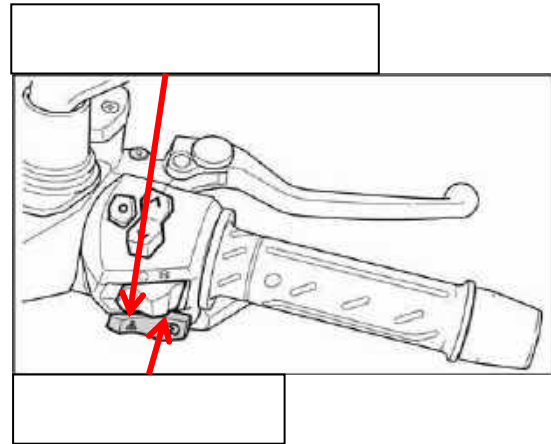

STARTER SW

	E	ST
FREE		
PUSH	○ — ○	
COLOR	G	Y/R

HAZARD SW

	HZ	BAT3
OFF		
ON	○ — ○	
COLOR	B/LI	Y/B

Engine Stop SW

	IG	BAT3
OFF		
RUN	○ — ○	
COLOR	B/W	B/G

Engine stop switch

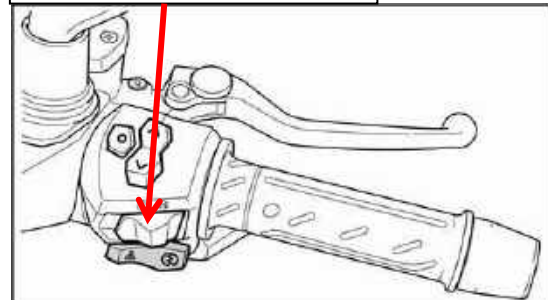

5.4. Left Handlebar Switch

Disconnect the left handlebar switch connector and check for continuity at switch side connector terminals.

Continuity should exist between the color code wires as follows:

WINKER SW

	WR	R	L
R	○	○	
N			
L	○		○
COLOR	GR	SB	O

HORN SW

	BAT4	HO
FREE		
PUSH	○	○
COLOR	BR/L	LG

DIMMER SW

	HL	HI	LO
LO	○		○
(N)	○	○	○
HI	○	○	
COLOR	L/W2	L	W

PASSING SW

	BAT4	HI
FREE		
PUSH	○	○
COLOR	BR/L	L

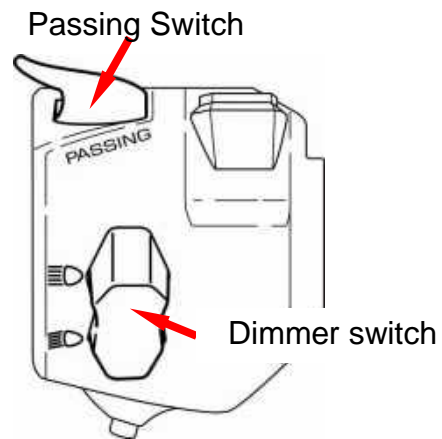
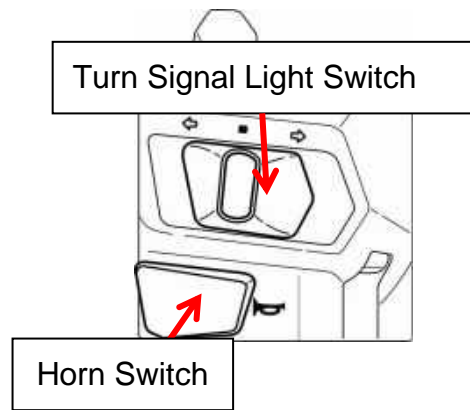

6. Luggage Box Light Sensor

6.1.INSPECTION

Remove the luggage box.

Disconnect the luggage box light sensor connector and check the luggage box light sensor for continuity between the sensor terminals.

There should be no continuity with the luggage box light sensor being covered up, and there should be continuity with the luggage box light sensor being not covered up.

To inspect the lamp and sensor of luggage box:

Sensor:

- * Voltage supply range: 8~16V.
- * It will light off 2 minutes later while opening the rider seat.
- * It will light off 3 seconds later while masking the sensor below 4cm height.

Lamp:

- * Disconnect the light coupler.
- * Connect 8~16V power supply to the terminal leads of lamp, then check whether the illumination works or not.

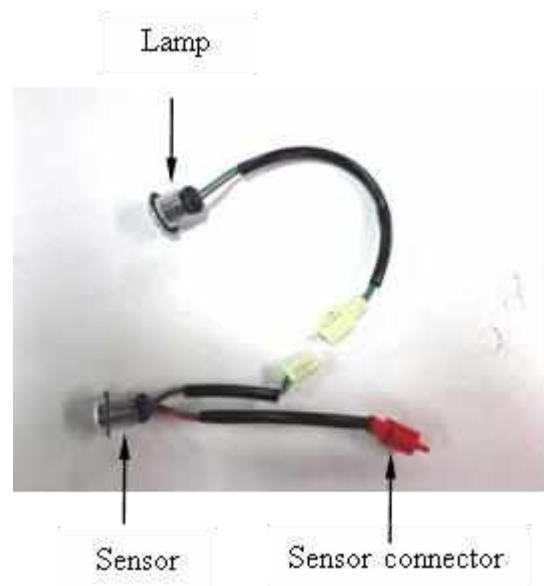

7. Oil pressure sensor

7.1. Inspection

Check the engine oil level is at the standard before inspection.

The engine oil pressure will maintain in a certain pressure after start the engine.

To inspect the oil pressure sensor, the ignition switch should be turned on.

The engine oil pressure indicator should light up automatically after turn on the ignition switch.

If the indicator does not come up, perform the following inspection process.

1. Remove the protective cap to disconnect the wire.
2. Connect the wire to ground directly to check if the indicator comes up automatically.
3. If the indicator does not light up still, check any of following situation: blown fuse, poor connection of , short circuit.

The engine oil pressure indicator should go off automatically after run the engine.

If the indicator does not go off, perform the following inspection process.

1. Inspect for oil leakage or seized situation.
2. If none of the above situations occur, the engine oil pressure sensor should be replaced.



7.2. Removal

Remove the protective cap and disconnect the wire.



Remove the engine oil pressure sensor.



7.3. Installation

Apply suitable sealant as shown and do not seize the sensor.

Tighten the oil pressure sensor to specified torque.

TORQUE: 2.1~3.0kgf-m

Install the protective cap and connect the wire.

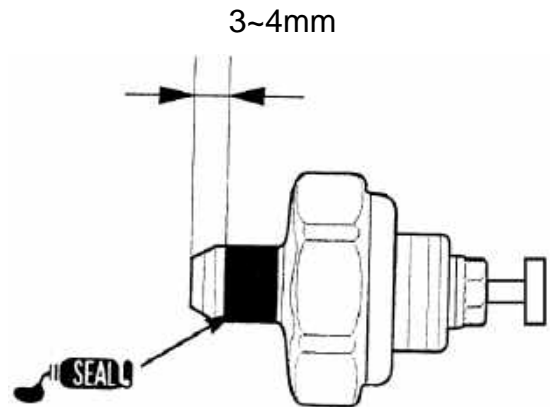

8. Fuel Pump

8.1. Removal

Remove the seat.

Remove the center cover

Remove the fuel pump connector

Be sure to relieve the fuel pressure before removing fuel pump or fuel hose.

Remove the 6 nuts (1) and fuel unit connectors(2) then remove the fuel hose.(3)

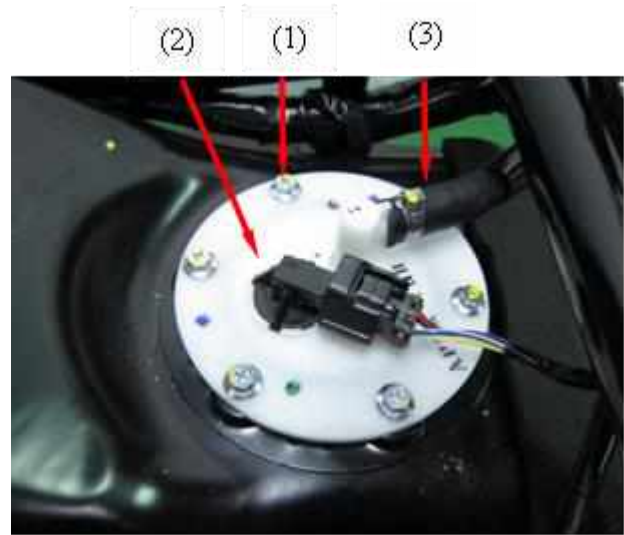

Remove the fuel pump.



Check the fuel pump O-ring. If it was damage, replace new one

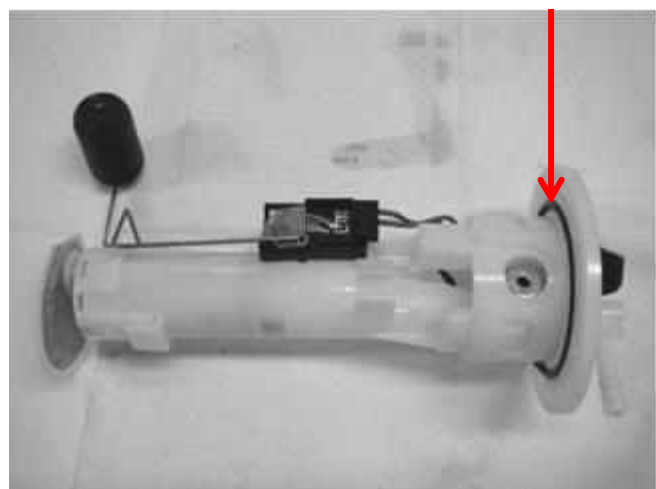

8.2. Inspection

Connect the fuel unit wire connectors and turn the ignition switch "ON".

- ※ **Before performing the following test, operate the turn signals to determine that the battery circuit is normal.**
- ※ **Use a good condition and fully charged battery to perform the inspection.**

Check the fuel meter for correct indication by moving the fuel unit float up and down.

Float Position	Display
Upper	Much (Full)
Lower	Less (Empty)

Wire Terminals	Display
Free	From Much to Less
Apply	From Less to Much

The fuel meter is normal if it operates as above indicated. If not, check for poorly connected terminals or shorted wires.

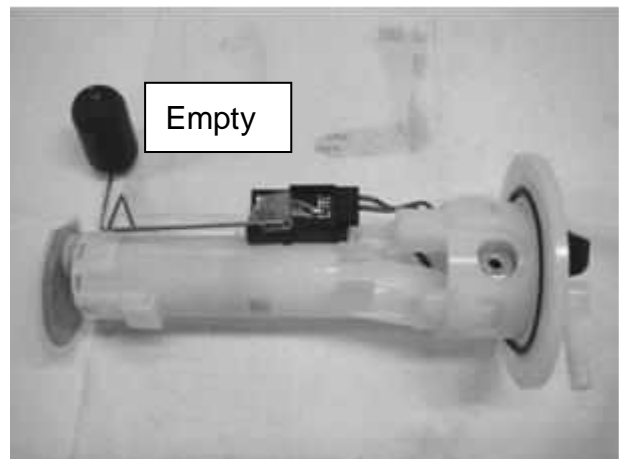
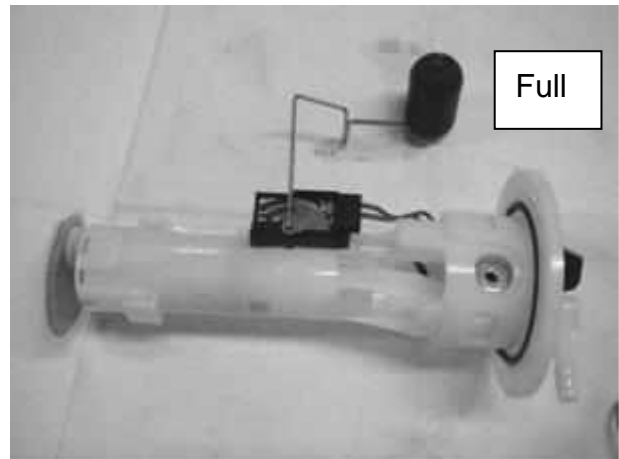

Measure the resistance between the Yellow/White and Blue/White terminals of the fuel unit connector.

Standard (at 20°C/68°F):

Float at full position	About 1100 Ω
Float at empty position	About 100 Ω

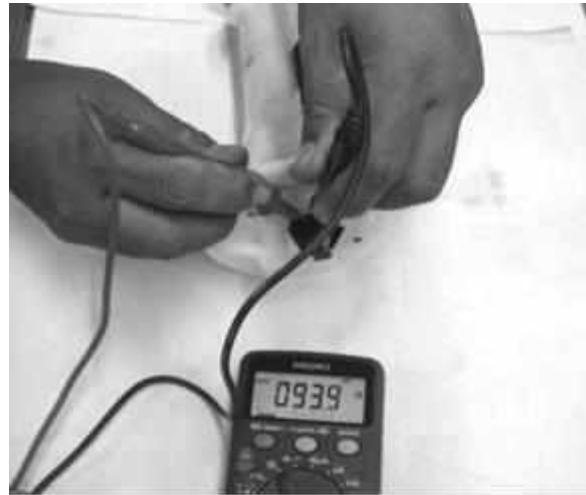

8.3. Installation

Installation is in the reverse order of removal.

Check the fuel hose routing is correct.

Check the fuel pump and the fuel gauge operate normally after installation.

9. Side Stand Switch

9.1. Inspection

Disconnect the side stand switch connector (1).

There should be continuity between the Yellow/Green and Green with the side stand retracted.

There should be continuity between the Yellow/Black and Green with the side stand applied.

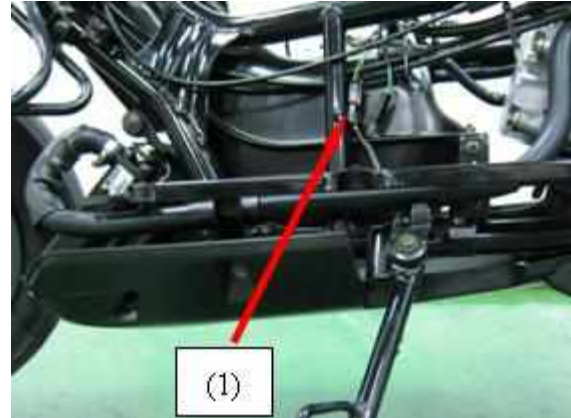

9.2. Removal

Disconnect the side stand switch connector.
Remove the bolt and side stand switch from the side stand.

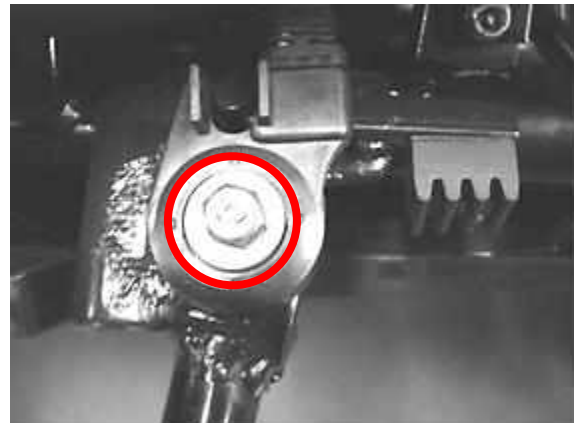

9.3. Installation

Installs the side stand switch aligning the groove on the switch with the pin on the side stand stay.

Install and tighten the side stand switch bolt securely.

Connect the side stand switch connector.

10. Horn

10.1. Inspection

Remove the front cover.

Disconnect the horn connectors (1) from the horn.

Connect a 12 V battery to the horn terminals.

The horn is normal if it sounds when the 12 V battery is connected across the horn terminals.

10.2. Removal/Installation

Disconnect the horn connectors from the horn.

Remove the bolt (2) and horn.

Installation is in the reverse order of removal.

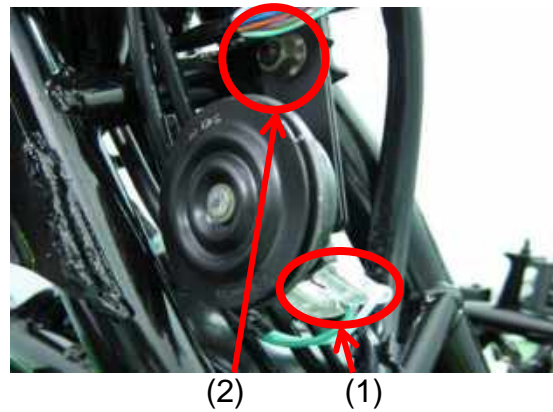

11. Rollover sensor

11.1. Inspection

Place the vehicle on a level ground and on its center stand.

Remove the front cover.

Turn on the ignition switch.

Use probes of a multimeter to test the voltage of the rollover sensor.

Terminals		Standard
(+): V/R	(-): G/P	5V (ECU voltage)
(+): B/L	(-): G/P	0.4~1.4V

If the vehicle tipping angle exceeds 65°, the engine will stop.

11.2. Removal/Installation

Disconnect the connector.

Remove the nut.

Remove the rollover sensor.

Remove the nuts.

Remove the bracket.

Install in the reverse order of removal.

※ The arrow mark which above the UP mark should point to upward.



Rollover sensor



Nut

Nuts



Arrow & UP mark

Anti-Lock Brake System (ABS)

1.	ABS	2
1.1.	Indicator Light	2
1.2.	Introduction	2
1.3.	Troubleshooting Outline	4
1.4.	Removal.....	7
1.5.	Installation.....	7
2.	Diagnostic Tool	8
2.1.	PC version.....	8
3.	Diagnostic Tool Operation	9
3.1.	Operation Instructions	9
3.2.	Connection	10
3.3.	DTC Inspect.....	11
3.4.	DTC Displayed.....	11
3.5.	DTC Cleared	12
3.6.	Data Analyze.....	12
3.7.	Air Bleeding	12
4.	DTC List	13
4.1.	Bosch ABS91 DTC List	13
4.2.	TCS DTC List	錯誤! 尚未定義書籤。
5.	Introduction to KYMCO TCS System	錯誤! 尚未定義書籤。

1. ABS

1.1. Indicator Light

The ABS indicator light in the meter position. This light will come on when the ignition switch is turned on and goes off shortly after the vehicle starts moving at speed 6km/hr. min. It stays off.

If something is wrong with the ABS, the indicator comes on and remains it. When the indicator light is on the ABS doesn't function but if the ABS fails, the conventional brake system will still work normally.

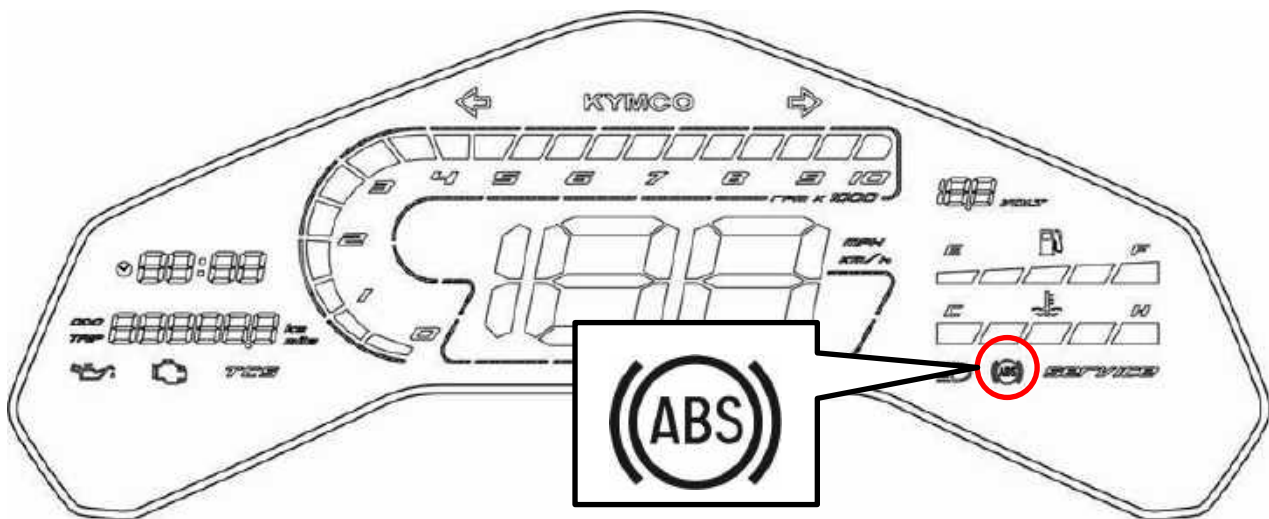

1.2. Introduction

ABS is designed to help prevent the wheels from locking up when the brakes are applied hard while running straight. The ABS automatically regulates brake force.

Intermittently gaining gripping force and braking force helps prevent wheel lock-up and allows stable steering control while stopping.

Brake control function is identical to that of conventional vehicle. The brake lever is used for the front brake and rear brake.

Although the ABS provides stability while stopping by preventing wheel lock-up, remember the following characteristics:

- ABS cannot compensate for adverse road conditions, misjudgment or improper application of brakes. You must take the same care as with vehicle not equipped with ABS.
- ABS isn't designed to shorten the braking distance. On loose, uneven or downhill surfaces, the stopping distance of a vehicle with ABS may be longer than that of an equivalent vehicle without ABS. Use special caution in such areas.

- ABS will help prevent wheel lock-up when braking in straight line but it cannot control wheel slip, which may be caused by braking during cornering. When turning a corner, it is better to limit braking to the light application of both brakes or not to brake at all. Reduce your speed before you get into the corner.
- The computer could inter-grade in the ABS compare vehicle speed with wheel speed. Since non-recommended tires can affect wheel speed, they may confuse, which can extend distance.

※ **Use of non-recommended tires may cause malfunctioning of ABS and lead to extended braking distance. The rider could have an accident as a result. Always use standard for this recommended vehicle.**

NOTICE:

- When the ABS is functioning, you may feel a pulsing in the brake lever. This is normal. You need not suspend applying brakes.
- ABS does not function at speeds of approx. 10 km/h or below.
- ABS does not function if battery is discharged or battery power supply malfunctions. (Light will come on)

1.3. Troubleshooting Outline

The ABS indicator light lights up to alert the rider when an abnormality is detected by the system. The service codes are stored in the ABS unit memory. The codes will not be erased unless manually cleared. After the fault has been corrected erase the service codes.

Even when the ABS is operating normally, the ABS indicator light may light up under the conditions listed below. Turn the ignition switch OFF to stop the indicator light. If the scooter runs without erasing the service codes, the light may light up again.

- After continuous riding on a rough road.
- When the ABS has been subjected to strong electrical interference.
- When tire pressure is abnormal. Adjust tire pressure.
- When a tire different in size from the standard size is being used. Replace with standard size.
- When the wheel is deformed. Replace the wheel.

Much of the ABS troubleshooting work consists of confirming continuity of the wiring. The ABS parts are assembled and adjusted by the manufacturer, so there is no need to disassemble or repair them. Replace the ABS hydraulic unit if needed.

The basic troubleshooting procedures are listed below.

- Carry out pre-diagnosis inspections as a preliminary inspection.
- Check wiring and connections from the ABS hydraulic unit connector to the suspected ABS part, using the diagnosis tool.

Special tool - Diagnosis tester: 3620A-LEB2-E00

- Visually inspect the wiring for signs of burning or fraying. If any wiring is poor, replace the damaged wiring.
- Pull each connector apart and inspect it for corrosion, dirt and damage. If the connector is corroded or dirty, clean it carefully. If it is damaged, replace it.
- Check the wiring for continuity.

Pre-diagnosis Inspection Chart 1

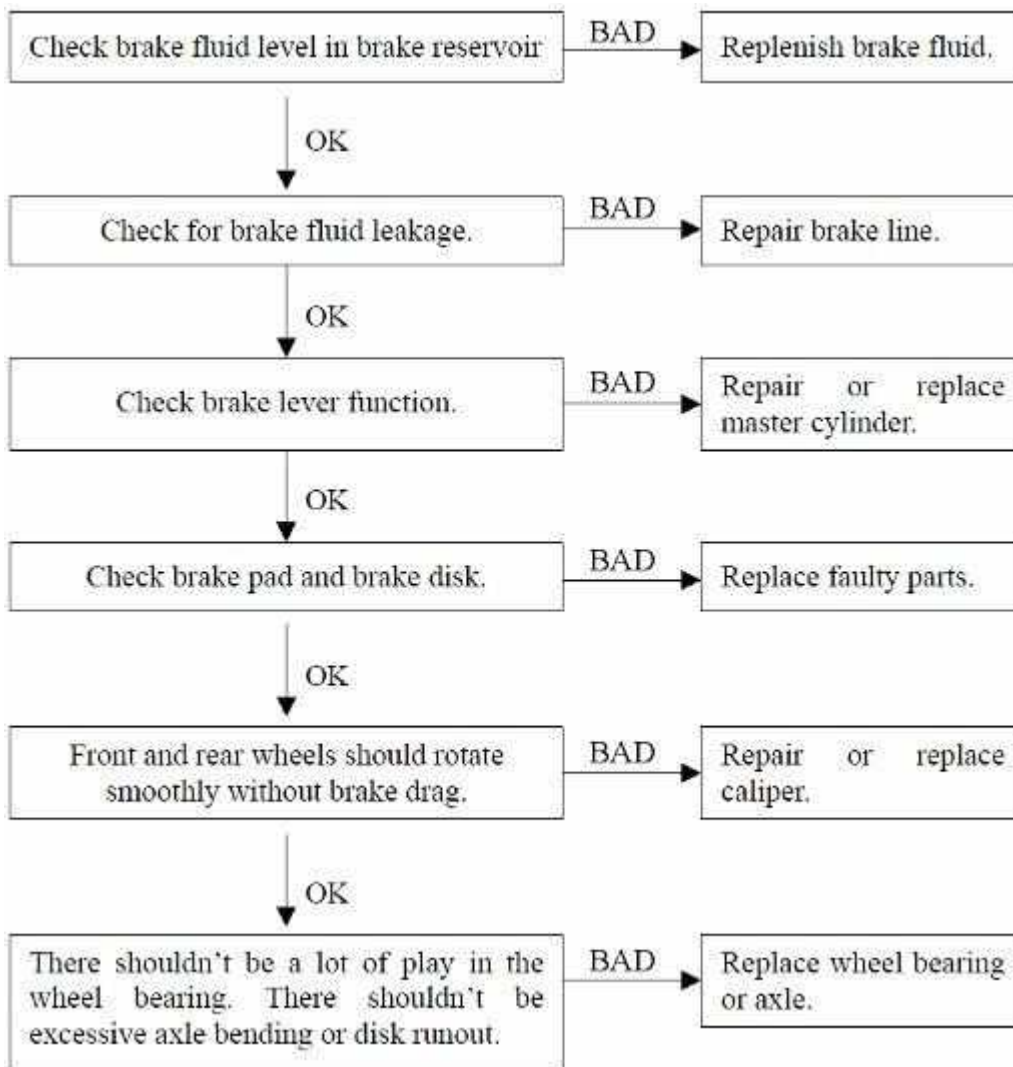

Pre-diagnosis Inspection Chart 2

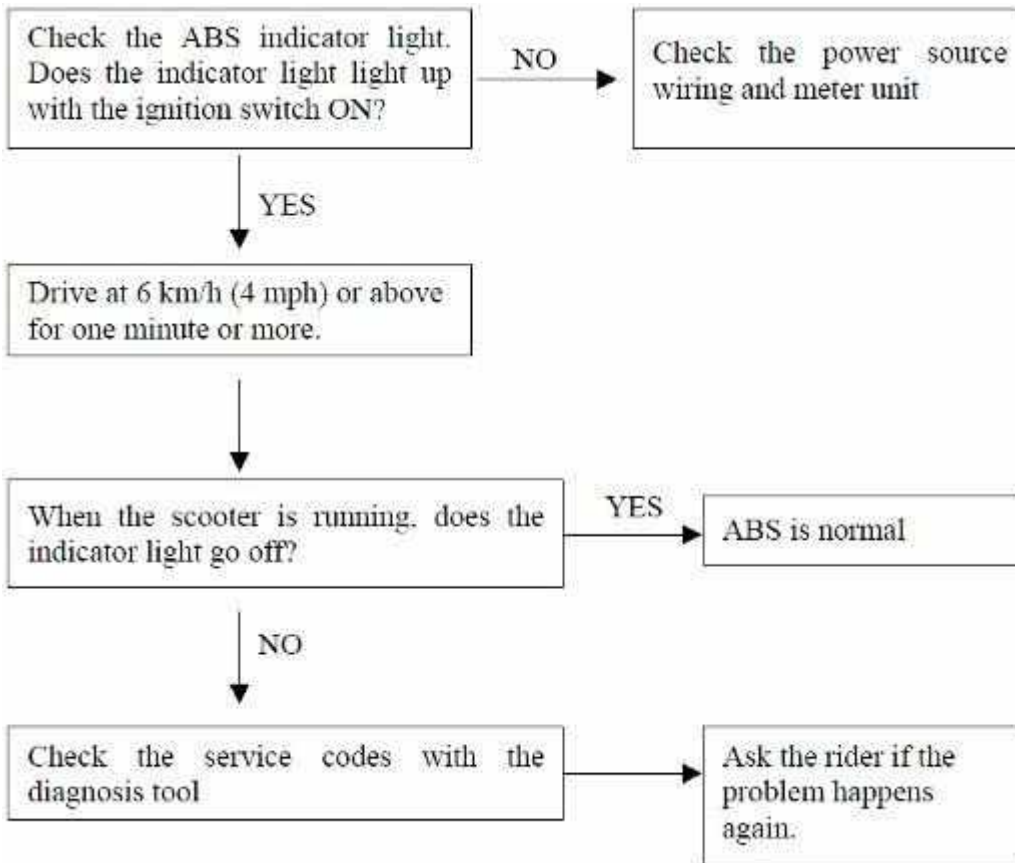

1.4. Removal

※ When replacing a new Hydraulic Unit, don't need to drain the brake fluid.

Place a cloth under the ABS module.
Remove the input and output bolts.

Disconnect the cable.
Be careful do not damage the joint claw.

Remove the bolts.
Remove the ABS module.

Rear brake fluid output Front brake fluid output



Rear brake fluid input Front brake fluid input

Bolts Joint claw



1.5. Installation

Install in the reverse order of removal.

TORQUE: 3~4 kgf-m

※ Install the brake fluid hoses in the correct positions.
※ Wipe off any remaining brake fluid.

Rear brake fluid output Front brake fluid output



Rear brake fluid input Front brake fluid input

2. Diagnostic Tool

2.1. PC version

Open the diagnostic tool software.



Remove the front cover.

Connect the integrated linker to the OBD connector.

Turn on the ignition switch.



OBD connector

Chose the ABS brake system.



Check the ECU version.

If any of components which are related to brake fluid is replaced, the air bleed procedure must be done.

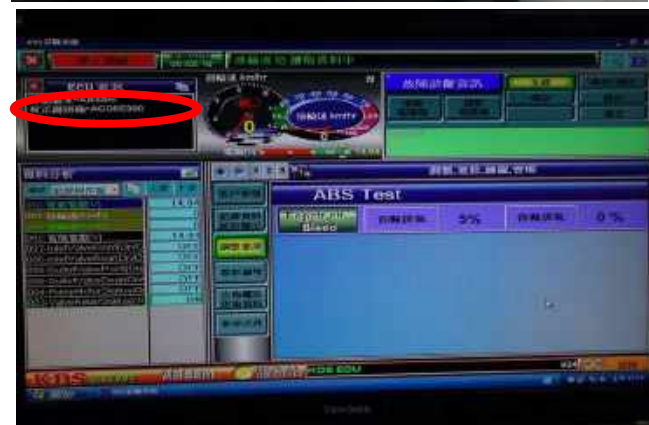

3. Diagnostic Tool Operation

3.1. Operation Instructions

Part No. 3620A-LEB2-E00

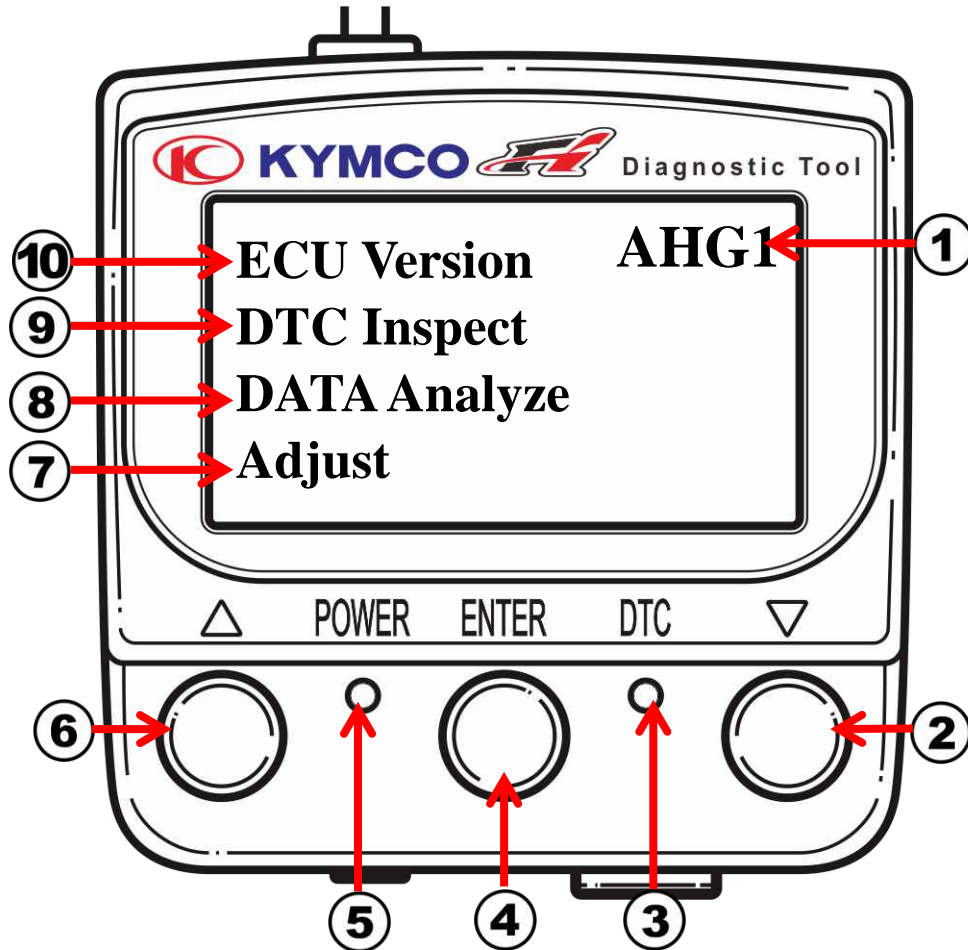

KEY FUNCTION

- | | |
|---------------------------------|---------------------------------------|
| ① Model No. | ⑥ UP Button |
| ② Down Button | ⑦ Adjust (TPI and ABV reset function) |
| ③ DTC indicator (Failure codes) | ⑧ DATA Analyze |
| ④ Enter or Exit | ⑨ DTC Inspect |
| ⑤ Power indicator | ⑩ ECU Version |

Note: For EURO models

Use the Sub cord, OBD diagnostics connector (part number:36205-LFA7-E00) to connect between vehicle and diagnostic tool.



←To: Vehicle

To Diagnostic tool →

3.2. Connection

1. Connect the sub cord to the OBD connector and then connect the KYMCO Fi diagnostic tool. (KYMCO Fi Diagnostic tool Power comes from vehicle's Battery)



OBD Connector

2. Put the side stand upward and ENG. stop switch is at "RUN" position.
3. Choose Fi ECU Version and press the enter button.
4. Press the down button 2 times to open the First diagnostic page.



5. Choose the ABS



6. Open the previous page and press the enter button again to back to the Main page.

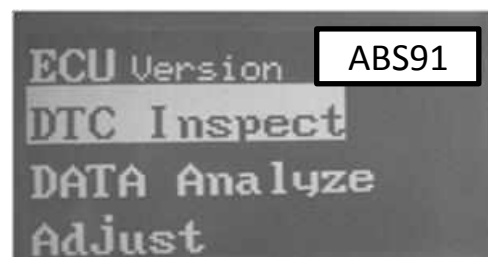

3.3.DTC Inspect

1. Choose DTC Inspect

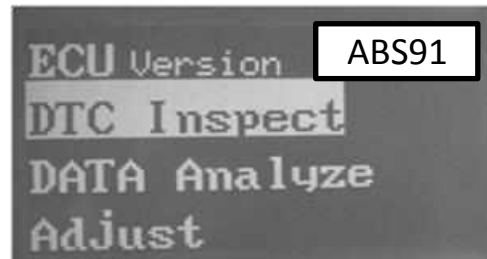

2. Load DTC (Active 、Occurred 、History)

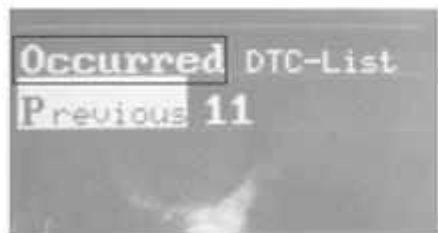
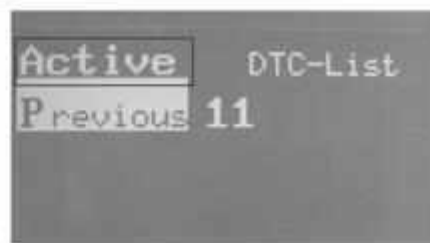
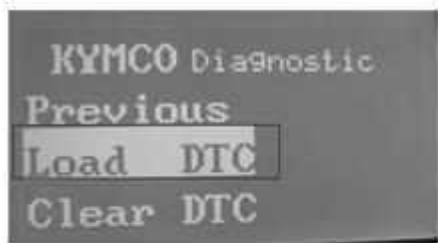

3.4.DTC Displayed

1. Rear wheel speed sensor disconnect



2. Front wheel speed sensor disconnect



3.5.DTC Cleared

1. Choose “Clear DTC” and then push “Enter” button.

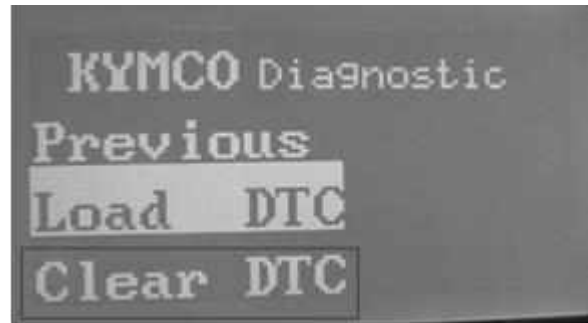

2. Clearing DTC completed until the DTC red lamp is off.

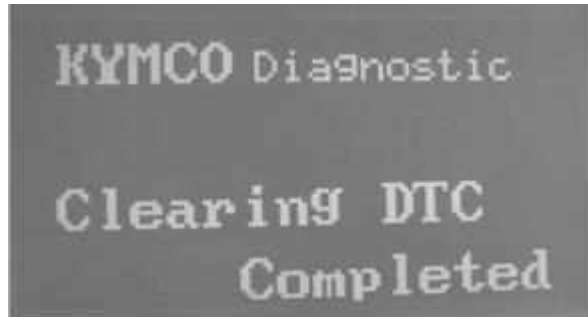

3.6.Data Analyze

1. Choose “DATA Analyze” and then push “Enter” button

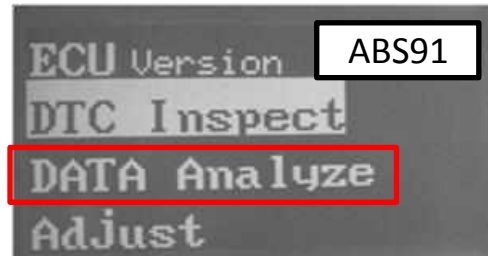

2. Front wheel speed & Rear wheel speed & Battery volt

Battery volt: Standard 9.6~16.7 V

※ You can turn the front or rear wheel to check if the wheel speed is figured.



3.7.Air Bleeding

1. Choose the Adjust
2. Choose the front or rear brake to perform air bleeding.

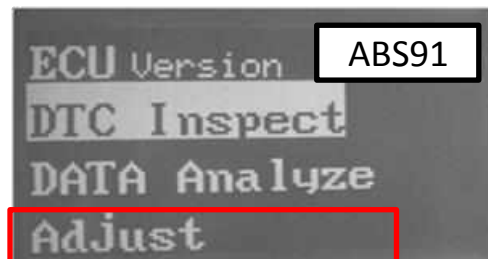

4. DTC List

4.1. Bosch ABS91 DTC List

Code NO	DTC Code	Description
01	5013	Rear Inlet Valve malfunction (EV)
02	5014	Rear Outlet Valve malfunction (AV)
03	5017	Front Inlet Valve malfunction (EV)
04	5018	Front Outlet Valve malfunction (AV)
05	5019	Valve Relay malfunction (Failsafe relay)
06	5025	Deviation between Wheel speeds (WSS_GENERIC)
07	5035	Pump Motor Malfunction
08	5042	Front wheel speed sensor malfunction-Plausibility
09	5043	Front wheel speed sensor Disconnection/gnd Short/Battery Voltage Short
10	5044	Rear wheel speed sensor malfunction - Plausibility
11	5045	Rear wheel speed sensor Disconnection/gnd Short/Battery Voltage Short
12	5052	Power Supply Malfunction (Under Voltage)
13	5053	Power Supply Malfunction (Over Voltage)
14	5055	ECU malfunction

EEC System

1.	Diagram	2
1.1.	Evaporates Emission Control System Diagram	2
1.2.	Pollution Emission System Diagram	2
2.	E.E.C System Introduction	3
2.1.	Evaporative Emission Control System	3
2.2.	Crankcase Emission Control System.....	3
2.3.	Exhaust Emission Control System.....	3
2.4.	Noise Exhaust Emission Control System.....	3
3.	Function	4
3.1.	Trouble Shooting	4
4.	Maintenance Schedule	5
4.1.	Maintenance schedule legend	錯誤! 尚未定義書籤。
5.	Maintenance Information	7
6.	Canister.....	8
6.1.	Removal	8
6.2.	Inspection	8
6.3.	Installation of canister	9
7.	P.C.V.	10
7.1.	Inspection	10
7.2.	Air filter	10
7.3.	Inspection of emission system	11
8.	Oxygen Sensor	12

1. Diagram

1.1. Evaporates Emission Control System Diagram

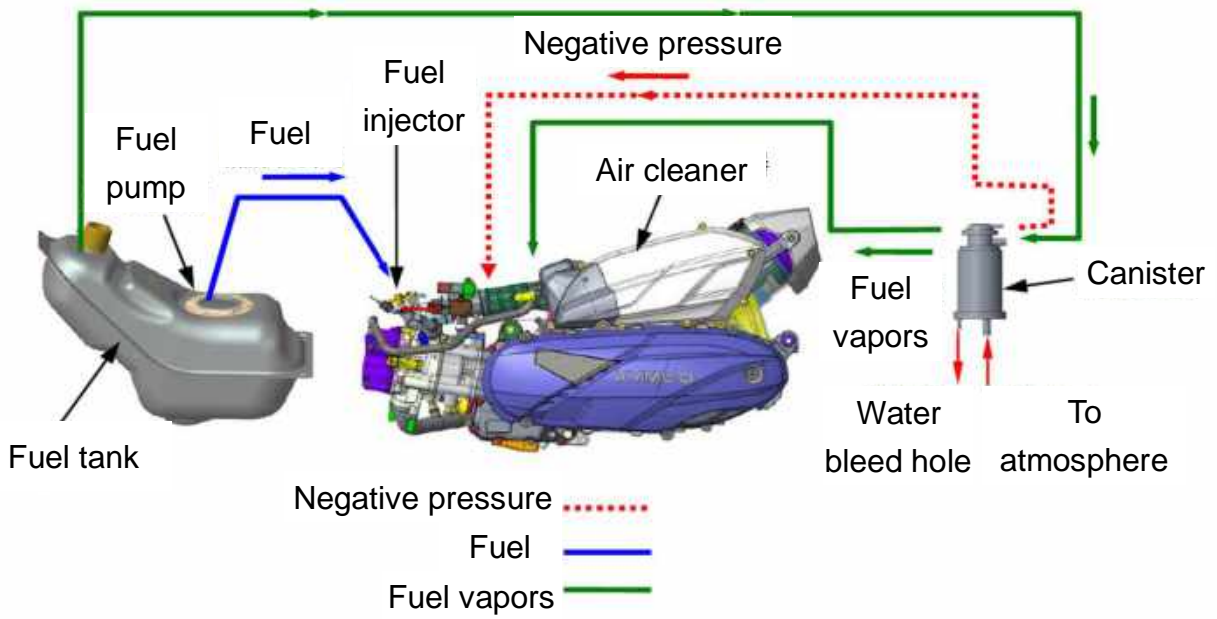

1.2. Pollution Emission System Diagram

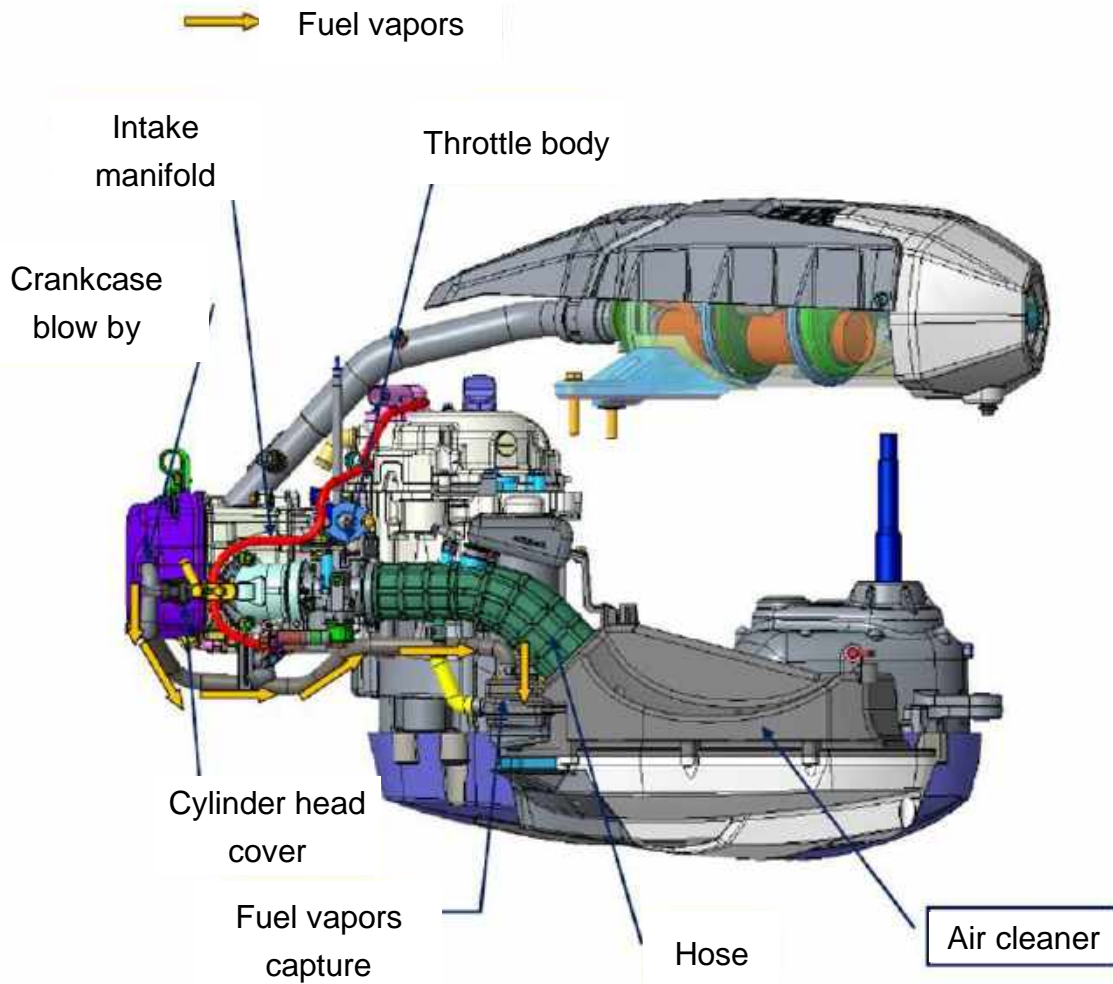

2. E.E.C System Introduction

WARNING:

- Before running the engine, make sure that the working area is well ventilated. Never run the engine in a closed area. The exhaust contains poisonous carbon monoxide gas, which may cause death to people.
- Gasoline is extremely flammable and is explosive under some conditions. The working area must be well ventilated and do not smoke or allow flames or sparks near the working area or fuel storage area.

2.1. Evaporative Emission Control System

The evaporative emission control system is used to prevent gasoline vapors from escaping into the atmosphere from the fuel tank and fuel system.

2.2. Crankcase Emission Control System

The scooter is equipped with a closed crankcase system. Blow-by gas is recycled into the combustion chamber via the intake system. This arrangement is to prevent blow-by gas from spreading to the atmosphere.

2.3. Exhaust Emission Control System

The exhaust emission from the scooter is controlled by combustion management, fuel delivery, ignition setting and exhaust system. The exhaust system also includes the catalytic converter in the muffler.

2.4. Noise Exhaust Emission Control System

The engine, intake and exhaust systems of the scooter are designed to comply with federal or local noise regulations. Do not modify the intake or exhaust system, this behavior will offend against the noise regulations.

Note: Do not adapt any original factory design and setting, which will deteriorate the sound or emission level.

3. Function

Item	Function	Description
Evaporative Emission Control Valve	It is used to prevent gasoline vapors from escaping into the atmosphere from the fuel tank and fuel system.	Storage the gasoline vapors to canister, conduct the gasoline vapors to engine by vacuum when starting the engine.
Canister	Storage the gasoline vapors from fuel tank and fuel system.	The gasoline vapors storage by canister, to meet the regulation, the HC emission can not exceeds 2 grams.
P.C.V	Recycle the fuel gas from the crankcase blow by.	Recycle the fuel gas from the crankcase blow by to the engine.
Oxygen Sensor	To control the air/fuel mixture in best condition.	Sending the mixture condition info to ECU by voltage signal, ECU controls the fuel injection to meet the emission regulation.
Catalyst	To reduce the emission of HC, CO and NOx produced from the exhaust gas.	Using the catalyst converts the HC and CO to CO ₂ and H ₂ O also reduce the NOx pollution.
ECU	To control the injector, ignition and bypass air of fuel injection system to reach the best driving condition.	ECU (Electric Control Unit), receiving sensor which equipped on engine to precisely control fuel injection and ignition to reduce the exhaust emission pollution.

3.1. Trouble Shooting

Low engine power, instable engine idle speed

- Clog in canister or tubes.
- Emission control valve malfunction.
- E.E.C. system tubes loosen or crack.
- ECU malfunction.

Engine idle speed and acceleration in bad condition

- Clog in canister or tubes.
- Emission control valve malfunction.

4. Maintenance Schedule

Perform the pre-ride inspection at each scheduled maintenance period. This interval should be judged by odometer reading or months, whichever comes first.

I: INSPECT AND CLEAN, ADJUST, LUBRICATE OR REPLACE IF NECESSARY

C: CLEAN R: REPLACE T: Tighten M: Maintain D: Diagnostic

Item	Maintenance Operation Item	Maintenance Interval															
		It depends on the mileage or the month.		Mileage	300	1000	2000	3000	4000	5000	6000	7000	8000	9000	10000	11000	12000
		Month	First time	1	2	3	4	5	6	7	8	9	10	11	12		
Lubrication System	Engine Oil	★	R	R	R	R	R	R	R	R	R	R	R	R	R	R	
	Oil Screen	★	C		C			C						C			
	Oil Filter	★	R					R						R			
	Gear Oil	★	R			R				R			R			R	
Fuel System	Fuel Pump	★			I/C			I/C						I/C			
	Throttle Cable	★			I			I						I			
Air Supply System	Air Element	★	Note 3, 4			I			R		I			R		I	
	Activated Carbon Canister	★				I			I					I			
	CVT Filter Wool	★							R					R			
	PCV Evaporative Emission Control Valve	★				I			I					I			
	O2 Sensor	★				I			I					I			
	Catalytic Converter	★				I			I					I			
Drivetrain	Cam Chain	★				I			I					I			
	CVT Driving Belt/Roller/Clutch Outer Sleeve	★				I			I			M		I			
	Rear Wheel Driving Belt	★	Note 2	I	I	I	I	I	I	I	I	I	I	I	I	I	
	Valve Clearance	★	Note 4			I			I					I			
Ignition System	Spark Plug	★				I								R			
	Ignition Circuit	★							I					I			
Engine Management System	Throttle Body	★	Note 4						M/I					M/I			
	Fuel Injector	★	Note 1,4			D/M			D/M		D/M			C		D/M	
	Idle Air Bypass Valve	★							D/M					D/M			
	Engine Temperature Sensor	★				D			D		D			D		D	
	Air Intake Pressure Sensor	★				D			D		D			D		D	
	Ignition Coil	★				D			D		D			D		D	
	Battery	★				D			D		D			D		D	
Brake System	Brake Lever Play			I	I	I	I	I	I	I	I	I	I	I	I	I	
	Brake Fluid	★		I	I	I	I	I	I	I	I	I	I	R	I	I	
	ABS Wheel Speed Sensor/Reading Disc	★							M/I					M/I			
	Brake pad lining	★		I	I	I	I	I	I	I	I	I	I	I	I	I	
Cooling System	Coolant Reservoir/ Coolant	★		I		I			I					I			
	Fin/Front Protection Screen of Radiator			I	I	I	I	I	I	I	I	I	I	I	I	I	
	Coolant hoses/Connector	★		I	I	I	I	I	I	I	I	I	I	I	I	I	
Others	Important Body Bolts	★		T	T	T	T	T	T	T	T	T	T	T	T	T	
	Tire Pressure/Tread			I	I	I	I	I	I	I	I	I	I	I	I	I	

4.1. Irregular Maintenance

1. Ignition System: if ignition failure, engine overheating or engine stalling problems are noticeable and occur constantly, perform maintenance and inspection.
2. Remove Carbon Deposits: If the horsepower of the engine decreases considerably, remove the carbon deposits in the valve, piston, throttle body, idle air bypass valve and fuel injector.
3. Drivetrain: If the top speed drops considerably, perform maintenance and inspection for the CVT parts and replace them when necessary.
4. Fuel Injector: Please remove the carbon deposits or gummy residues inside the fuel injector when the vehicle has not been operated for a long time.
5. Fin/Front Protection Screen of Radiator: Check and clean it every 1000 km. Perform cleaning and maintenance as early as possible if driving in dusty and rainy areas.
6. ABS Wheel Speed Sensor/Reading Disc: Perform maintenance and inspection every 5000 km. Replace the sensor when necessary.

4.2. Notes

1. We recommend that you add a bottle of KYMCO fuel injector cleaner every 1000 km to the fuel tank.
2. An air blow gun must be used to clean the dust and foreign objects inside the belt wheel for models with rear wheel driving belt. Check the belt for crack or fracture and replace it when necessary. Check whether the tension of belt is within the specification. Adjust it to the range within the specification when necessary.
3. If the vehicle is often running in dusty areas, clean and replace the air element more often for longer service life.
4. To ensure fuel efficiency and mechanical performance of the vehicle, be sure to perform cleaning and maintenance for fuel injector, throttle body, valve clearance and air filter based on the mileage (or month).
5. It is suggested that the maintenance item marked ★ must be performed by a KYMCO dealer.

5. Maintenance Information

Note of maintenance:

- Flame or spark should keep away when performing maintenance.
- Install the tubes in correct position.
- If the tubes broken should be replaced with a new one.
- The tubes should be installed tightly.
- The leakage hole should be installed downward.

Tool

Vacuum pump

Pressure pump

Maintenance standard

Emission Vacuum Standard	45m/mHg
Capacity Of Canister	90cc
Install Angle	incline 60°

Evaporative Emission Control System

The location of tube connection diagram.

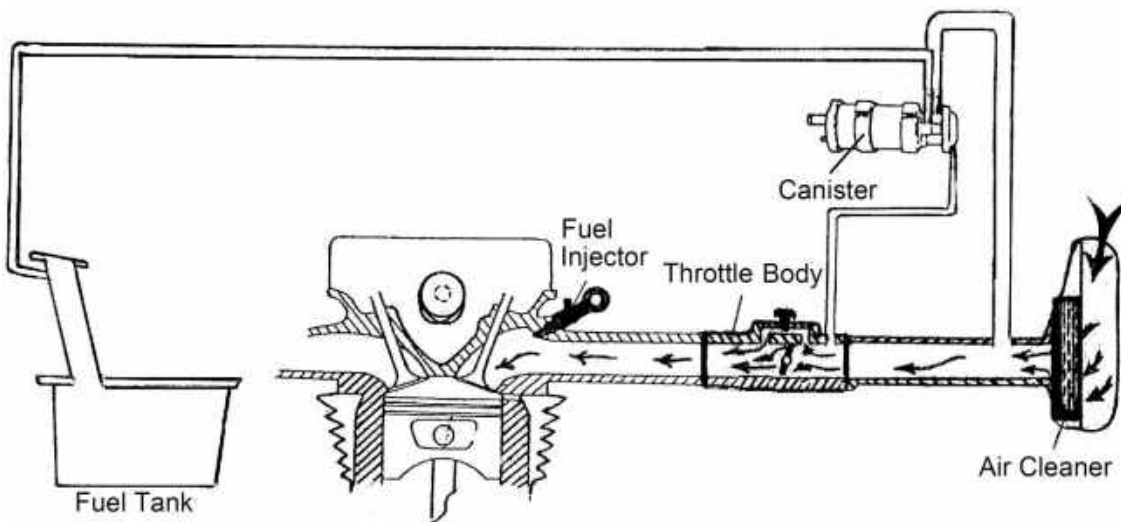

Leakage checking

1. Connection between canister and fuel tank.
2. Tubes of canister.

6. Canister

6.1. Removal

1. Remove the windshield, front cover and head light assembly.
2. Remove the canister tube set and canister.



Canister

6.2. Inspection

Canister Evaporative Control Valve

Connect a vacuum pump to the tube of canister. (Follow the illustration below.)

Applying 250m/mHg pressure to the canister evaporative control valve.

If the pressure will be kept without change obviously in one minute, that means the valve are with good condition, otherwise the valve malfunction, a new canister should be replaced.

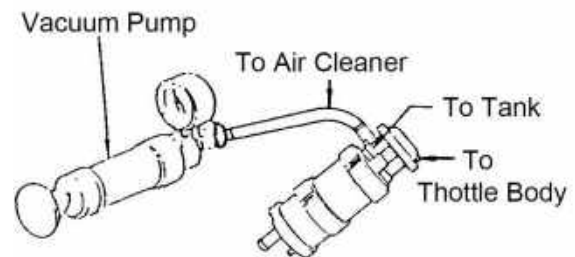

Connect a vacuum pump to the tube of canister. (Follow the illustration below.)

Applying 45m/mHg vacuum pressure to the canister evaporative control valve.

If the pressure will be kept without change obviously in one minute, that means the valve are with good condition, otherwise represents the valve with malfunction. A new canister should be replaced.

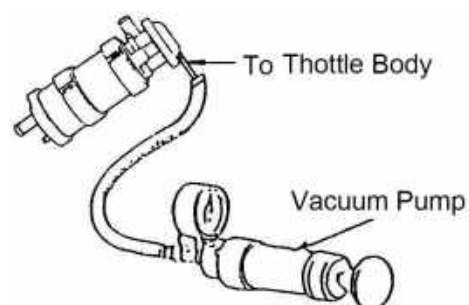

Flow Rate of the Canister Vacuum Valve

1. Using a vacuum pump connecting to the vacuum tube of canister and apply 45m/mHg of negative pressure.
2. Apply pressure to the emission control valve of canister, if the flow rate above 9.4 liters per minute that means the valve is in good condition, otherwise the canister should be replaced.

※ Always using the pump by manual, do not apply high pressure for testing to prevent the valve from malfunction.

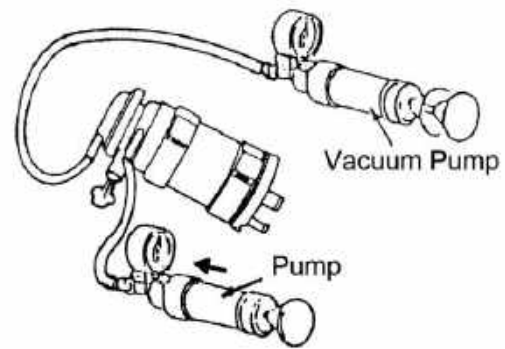

6.3. Installation of canister

1. Installation is the reverse order to the dismantling.
2. Connect the tubes and circlips firmly.

※ The tube should not be wrenched or crashed and never refit the canister.



Canister

7. P.C.V.

7.1. Inspection

Check the



Canister



Air filter cover

7.2. Air filter

Replace the air filter according to the Maintenance Schedule, and more often in exceptionally rainy or dusty areas.

Remove the screws from the air cleaner cover, then remove air cleaner cover.

Remove screws from the air cleaner element, then remove and discard this air cleaner element.

The new air cleaner element installation is in the reverse order of removal.

Use the KYMCO genuine air cleaner element or an equivalent air cleaner element specified for your model. Using the wrong KYMCO air cleaner element or a non-KYMCO air cleaner element which is not of equivalent quality may cause premature engine wear or performance problems.



Ail filter element

- ※ **The air cleaner element has a viscous type paper element. Do not clean it with compressed air.**
- ※ **Be sure to install the air cleaner element and cover securely.**

7.3. Inspection of emission system

Inspect the air cleaner.

Inspect the spark plug.

Inspect the ignition system.

Plug in the diagnostic tool to check the information.

Warm up the engine reach above 80°C.

This model equipped the catalyst in the muffler to reduce the pollution emission.

Inspect Catalyst Converter

Inspect catalyst converter efficiency at idle speed.

Warm up the engine 8~10 minutes, connect to emission machine.

To check the CO value before catalyst and after.

Normally, measuring after catalyst converting, the CO figure will be lower than the CO figure before catalyst converting.

If the number is abnormal, the catalyst converter could be deteriorated, the exhaust pipe should be replaced to prevent from the further pollution.

8. Oxygen Sensor



It uses DC-8-16V Battery Power with 4 pins: one power pin, one heater pin, one signal output pin and one earthing pin. The sensor is installed to the front pipe of exhaust pipe to detect the oxygen concentration of exhaust gas for determining if ECU shall instruct to increase or reduce fuel supply for meeting waste gas emission standard of environment legislation. When the temperature of exhaust is less than 350°C, the sensing portion cannot be activated and there is no signal output, and ECU will turn on the heater inside sensor to accelerate the temperature rise of sensor and cause the Oxygen Sensor to work normally. In normal hours, the impedance of heater is 7.7 +/- 1.2 ohm and can be told with multimeter. Output of sensor after the engine is warmed up is

A/F <14.7 (mixing ratio too thick) >0.7V

A/F > 14.7 (Mixing ratio too thin) <0.18V

Inspection and adjustment of emission

1. Start the engine and warm up for several minutes engine temperature 80~90°C, connect the diagnostic tool to check the information.
2. Idle speed should be in standard.
3. The emission machine should be connected to the front of the exhaust pipe measure hole. (Before Catalyst Converter)
4. Standard : CO:0.3~1.5 %
5. If the figure is out of range, check with the injection relative components.(For example, injector, fuel pump...etc.)
6. If the problems insist, please check the emission related system and check if there is any leakage from the cylinder head inlet/outlet valve.